



Instruction Manual



ES-FLOW™ 1xxl Ultrasonic Liquid Flow Meter/Controller

Doc. no.: 9.17.145 rev. J Date: 24-07-2023



ATTENTION

Please read this document carefully before installing and operating the product.
Not following the guidelines could result in personal injury and/or damage to the equipment.
Keep this document for future reference.



Copyright

© 2023 Bronkhorst High-Tech B.V. - All rights reserved.

Bronkhorst® is a registered trademark of Bronkhorst High-Tech B.V.
All other trademarks are the property of their respective owners.

Disclaimer

The illustrations in this document serve to provide general notices regarding correct operation. The illustrations are simplified representations of the actual situation and may differ from the actual product.

Bronkhorst High-Tech B.V. reserves the right to modify or improve its products and documentation without notice. Prior to work, check whether a newer version of this document is available on the Bronkhorst website.

Symbols in this document



Important information. Disregarding this information could increase the risk of damage to the equipment, or the risk of personal injuries.



Tips, useful information, attention points. This will facilitate the use of the instrument and/or contribute to its optimal performance.



Additional information available in the referenced documentation, on the indicated website(s) or from your Bronkhorst representative.

Receipt of equipment

Check the outside packaging box for damage incurred during shipment. If the box is damaged, the local carrier must be notified at once regarding his liability. At the same time a report should be submitted to your Bronkhorst representative.

Carefully remove the equipment from the box. Verify that the contents of the package was not damaged during shipment. Should the equipment be damaged, the local carrier must be notified at once regarding his liability. At the same time a report should be submitted to your Bronkhorst representative.

If the product is damaged, it should not be put into service. In that case, contact your Bronkhorst representative for service.



- *Check the packing list to ensure that you received all items included in the scope of delivery.*
- *Do not discard spare or replacement parts.*

See [Removal and return instructions](#) for information about return shipment procedures.

Equipment storage

- The equipment should be stored in its original package in a climate controlled storage location.
- Care should be taken not to subject the equipment to excessive temperatures or humidity.
- See technical specifications (data sheet) for information about required storage conditions.

Warranty

Bronkhorst® products are warranted against defects in material and workmanship for a period of three years from the date of shipment, provided they are used in accordance with the ordering specifications and not subject to abuse or physical damage. Products that do not operate properly during this period may be repaired or replaced at no charge. Repairs are normally warranted for one year or the balance of the original warranty, whichever is the longer.



See also section 9 (Guarantee) of the Conditions of sales:
www.bronkhorst.com/int/about/conditions-of-sales/

The warranty includes all initial and latent defects, random failures, and indeterminable internal causes. It excludes failures and damage caused by the customer, such as contamination, improper electrical hook-up, physical shock etc.

Re-conditioning of products primarily returned for warranty service that is partly or wholly judged non-warranty may be charged for.

Bronkhorst High-Tech B.V. or affiliated company prepays outgoing freight charges when any part of the service is performed under warranty, unless otherwise agreed upon beforehand. The costs of unstamped returns are added to the repair invoice. Import and/or export charges as well as costs of foreign shipping methods and/or carriers are paid by the customer.

General safety precautions

This product is intended for use by qualified personnel who recognize shock hazards and are familiar with the safety precautions required to prevent possible injury. Read the operating information carefully before using the product.

Before operating, make sure the line cord is connected to a properly grounded power receptacle. Inspect the connecting cables for cracks or breaks before each use.

The equipment and accessories must be used in accordance with their specifications and operating instructions, otherwise the safety of the equipment may be impaired.

Opening the equipment is not allowed. There are no user serviceable parts inside. In case of a defect please return the equipment to Bronkhorst High-Tech B.V.

One or more warning signs may be attached to the product. These signs have the following meaning:



General warning; consult the instruction manual for handling instructions



Surface may get hot during operation



Shock hazard; electrical parts inside

To maintain protection from electric shock and fire, replacement components must be obtained from Bronkhorst. Standard fuses, with applicable national safety approvals, may be used if the rating and type are the same. Non-safety related components may be obtained from other suppliers, as long as they are equivalent to the original component. Selected parts should be obtained only through Bronkhorst, to maintain accuracy and functionality of the product. If you are unsure about the suitability of a replacement component, contact your Bronkhorst representative for information.

Table of contents

1	Introduction	7
1.1	Scope of this manual	7
1.2	Intended use	7
1.3	Product description	7
1.4	Documentation	8
1.5	Model key	10
1.5.1	Customized I/O options	11
2	Installation	13
2.1	Functional properties	13
2.2	Mounting	13
2.2.1	Location in fluid system	13
2.2.2	Orientation	14
2.2.3	Hygienic applications	14
2.3	Fluid connections	14
2.4	Electrical connections	15
2.5	Communication interface	15
3	Operation	16
3.1	Powering up and powering down	16
3.2	First use	16
3.3	User interface	16
3.3.1	Main screen functions	17
3.3.1.1	Unlocking buttons	17
3.3.1.2	Selecting display information	17
3.3.1.3	Selecting screen area	17
3.3.1.4	Editing setpoint	18
3.3.1.5	Resetting counter	18
3.3.1.6	Resetting alarm	19
3.3.2	Menu navigation	19
3.3.2.1	Password protection	20
3.3.2.2	Editing string	20
3.3.2.3	Editing list selection	21
3.3.3	Settings menu	21
3.3.3.1	Readout	21
3.3.3.2	Controller	22
3.3.3.3	Counter/totalizer	23
3.3.3.4	Alarm	25
3.3.3.5	Setup	26
3.3.3.6	Advanced	27
3.3.4	Security menu	28
3.3.4.1	Changing password	29
3.3.4.2	Resetting password	29
3.3.5	LED indications	30
3.3.5.1	Interface status	31
3.3.5.2	DeviceNet™	31
3.3.6	Multifunctional switch	32
3.3.6.1	Normal operating functions	32

3.3.6.2	Control mode - readout/change	32
3.3.6.3	Network settings - readout/change	33
3.3.6.4	Disabling multifunctional switch	35
3.4	Digital parameters	35
3.4.1	General	36
3.4.2	Measurement and control	37
3.4.2.1	Secondary outputs	37
3.4.2.2	Advanced measurement and control	37
3.4.3	Alarms	38
3.4.4	Counter and totalizer	40
3.4.5	Network configuration	42
3.4.6	Fluid	43
3.4.7	Controller	44
3.4.8	Master/slave configuration (FLOW-BUS)	46
3.4.9	Device identification	46
3.4.10	Special parameters	47
3.4.10.1	Default control mode	49
3.5	Adjusting zero point	49
3.5.1	Autozero function	50
3.5.2	Manual procedure	50
3.5.3	Digital procedure	50
4	Maintenance	51
4.1	Cleaning	51
4.2	Calibration	51
5	Troubleshooting and service	52
5.1	Common issues	52
5.2	Service	54
6	Returns	55
6.1	Removal and return instructions	55
6.2	Disposal (end of lifetime)	55
	Parameter index	57

1 Introduction

1.1 Scope of this manual

This manual covers general product information, installation and operating instructions and troubleshooting tips for the **ES-FLOW™ 1xxl** digital volume flow meter/controller for liquids.



1.2 Intended use

The **ES-FLOW™ 1xxl** has been designed to accurately measure and control low volume flows with high precision and a limited pressure drop. A wide range of liquids can be measured independent of fluid density, temperature and viscosity.

When ordered as a 3-A compliant instrument, the ES-FLOW™ 1xxl is suited for hygienic (food processing) applications and Clean-in-place (CIP). The end user is responsible for the selection and application of suitable (FDA-compliant) sealing materials.



The wetted materials incorporated in the ES-FLOW™ 1xxl are compatible with media and conditions (e.g. pressure, temperature) as specified at ordering time. If you are planning to use the product (including any third party components supplied by Bronkhorst, such as pumps or valves) with other media and/or other conditions, always check the wetted materials (including seals) for compatibility. See the technical specifications of the product and consult third party documentation (if applicable) to check the incorporated materials.

Responsibility for the use of the equipment with regard to its intended use, suitability for the intended application, cleaning and compatibility of process media with the applied materials lies solely with the user.

The user is responsible for taking the necessary safety measures to prevent damage and/or injury while working with the equipment and process media (as described in the associated Material Safety Data Sheets).

Where appropriate, this document recommends or prescribes safety measures to be taken with respect to media usage or working with the described equipment under the specified conditions. However, this does not relieve the user of aforementioned responsibility, not even if such is not explicitly recommended or prescribed in this document.

Bronkhorst High-Tech B.V. cannot be held liable for any damage and/or injury resulting from unintended, improper or unsafe use, or use with other media and/or under other process conditions than specified at ordering time.

1.3 Product description

The **ES-FLOW™ 1xxl** is a precise and compact volume flow meter with control function for liquids, based on a novel ultrasonic technology.

Measuring principle

Measuring is done in a straight tube, without obstructions or dead spaces. Multiple transducers measure both the surface acoustic wave and the transit time through the media. All up- and down-stream combinations are recorded and processed in nanoseconds. The sound wave velocity and the surface area are recalculated to the volume flow value. This ultrasonic measuring method is fast, accurate and inherently bi-directional.

Application

The combination of a straight sensor tube with zero dead volume, self-drainability and hygienic connections, makes the ES-FLOW™ especially suitable for hygienic applications. Examples of typical use are the measuring of food ingredients like flavourings or syrups, or measuring concentrates in CIP units. For non-hygienic applications, the instrument can be equipped with compression type fittings. Wetted parts are made of stainless steel, the housing has a high ingress protection rating.

Operation

The **ES-FLOW™ 1xxl** can be operated with the integrated readout and control unit, as well as digitally, via RS-232 or fieldbus (Modbus, FLOW-BUS, PROFIBUS DP, PROFINET, DeviceNet™ or CANopen), or in analog mode. The readout and control unit has a capacitive touchscreen with a TFT display. The fluid temperature can be read out as a secondary output. An on-board PID controller can be used to drive a control valve or pump, establishing a complete, compact control loop. By default, the instrument is supplied with the readout and control unit above the measuring tube (assuming the flow direction is to the right). If so required, the flow direction and display orientation can be customized to support a convenient reading angle. The illustrations in this manual are based on the default orientation.

Multi-range

The **ES-FLOW™ 1xxl** offers multi-range functionality: factory calibrated ranges can be re-ranged to a different full scale range. Because of the extremely high linearity of the sensor, this does not affect the original accuracy specifications. The instrument comes with a calibration certificate for all supported full scale ranges. The actual full scale of the instrument is set to a value as ordered.

1.4 Documentation



The documentation listed in the following table is available on the **ES-FLOW™** product pages under www.bronkhorst.com/products

Type	Document name	Document no.
Manuals	Instruction Manual ES-FLOW™ 1xxl (this document)	9.17.145
Hook-up diagrams	Hook-up diagram Analog/RS-232	9.16.252
	Hook-up diagram CANopen	9.16.250
	Hook-up diagram DeviceNet™	9.16.245
	Hook-up diagram FLOW-BUS	9.16.247
	Hook-up diagram Modbus	9.16.246
	Hook-up diagram PROFIBUS DP	9.16.248
	Hook-up diagram EtherCAT® / EtherNet/IP / Modbus-TCP / POWERLINK / PROFINET	9.16.251
	Hook-up diagram optional bus and I/O configurations	9.16.249
Dimensional drawings	Dimensional drawing ES-103I / ES-113I	Mk I: 7.15.194 Mk II: 7.15.217



The documentation listed in the following table can be downloaded from www.bronkhorst.com/downloads

Type	Document	Document no.
Manuals	Manual CANopen interface	9.17.131
	Manual DeviceNet™ interface	9.17.026
	Manual EtherCAT interface	9.17.063
	Manual EtherNet/IP interface	9.17.132
	Manual FLOW-BUS interface	9.17.024
	Manual Modbus ASCII/RTU/TCP interface	9.17.035
	Manual PROFIBUS DP interface	9.17.025
	Manual POWERLINK interface	9.17.142
	Manual PROFINET interface	9.17.095
Manual RS-232 interface	9.17.027	
Certificates	EU Declaration of Conformity	9.06.021

Calibration certificates are part of the scope of delivery unless otherwise agreed.

1.5 Model key

The model key on the serial number label contains information about the technical properties of the product as ordered. The actual properties of your instrument can be retrieved from the diagram below.

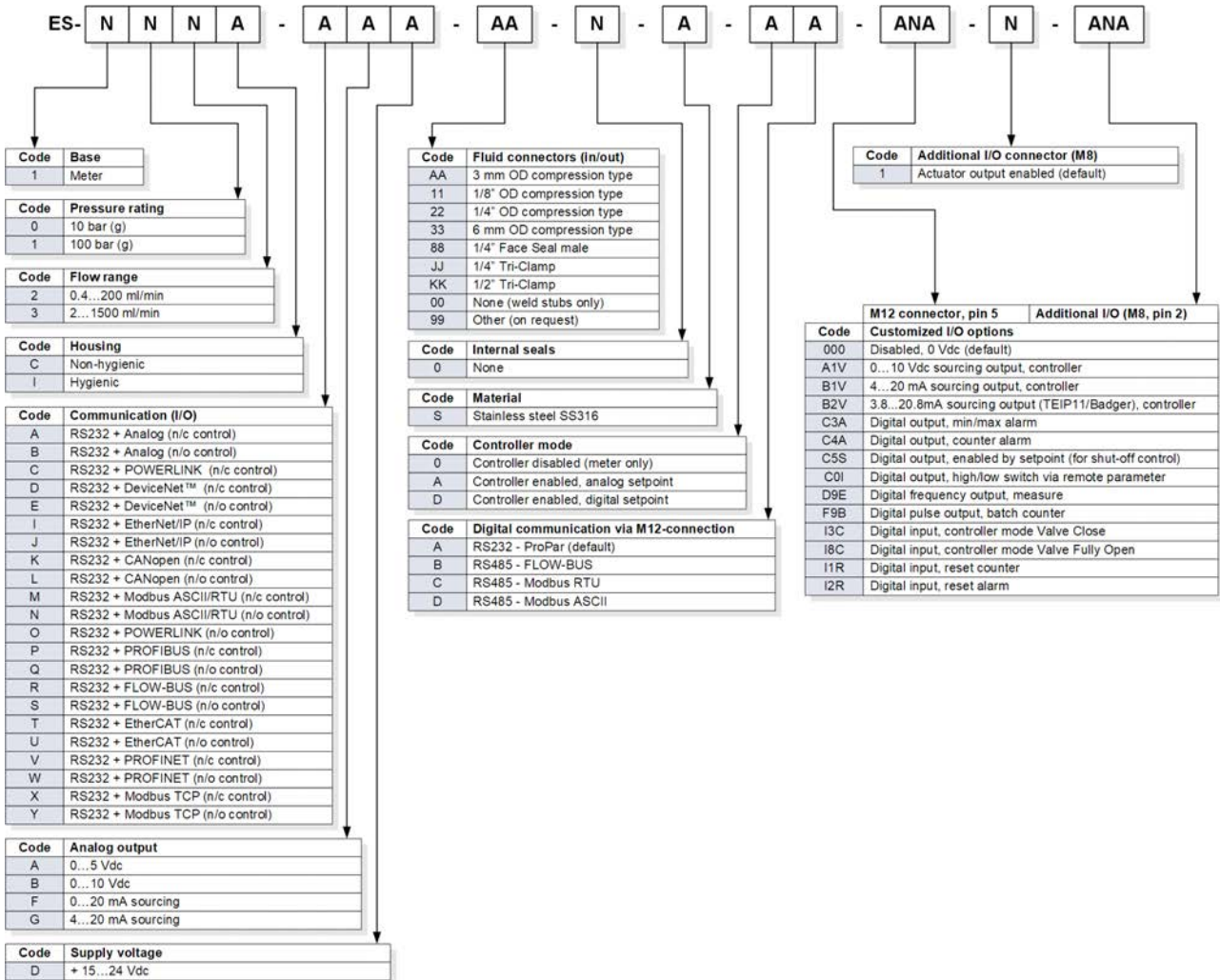

1.5.1 Customized I/O options

ES-FLOW™ 1xxl instruments offer various customized input/output functions through pin 5 of the [power connector](#) and through pin 2 of the [actuator output connector](#) as an option. I/O options are factory installed as specified at ordering time, and cannot be changed manually.

The last 3 groups of the model key on the serial number label indicate the installed I/O configuration. The possible configurations are described in the table below. See the [hook-up diagram](#) for custom bus and I/O configurations for an explanation of the codes.

Code	Description
000	Disabled, pin 5 is pulled down to 0 Vdc (default selection)
A1V*	<p>0...10 Vdc sourcing output, controller Analog signal for pump or external valve steering (control signal only)</p> <p>When the controller output is used for pump or external valve steering (mass flow meters only), make sure to set parameter <i>Valve maximum</i> to 0.3 [A]. For mass flow controllers, the controller output is limited to a value below 10Vdc, due to the maximum valve current restriction.</p>
B1V*	<p>4...20 mA sourcing output, controller Analog signal for pump or external valve steering (control signal only).</p> <p>When the controller output is used for pump or external valve steering (mass flow meters only), make sure to set parameter <i>Valve maximum</i> to 0.3 [A]. For mass flow controllers, the controller output is limited to a value below 20 mA, due to the maximum valve current restriction.</p>
B2V*	<p>3.8...20.8 mA sourcing output, controller Analog signal for Badger Meter valve with TEIP11 signal converter (control signal only)</p>
C3A	<p>Digital output, min/max alarm During a min/max alarm, pin 5 is pulled down to 0 Vdc.</p>
C4A	<p>Digital output, counter alarm During a counter alarm, pin 5 is pulled down to 0 Vdc.</p>
C5S	<p>Digital output, enabled by setpoint (for shut-off control) Pin 5 is pulled down to 0 Vdc at a controller setpoint, e.g. for shut-off valve activation.</p> <p>For factory selected analog control (...-A#-C5S): If parameter <i>Control mode</i> is set for analog control by factory, the minimum setpoint at which the device (shut-off valve) connected to pin 5 is activated is 1.9%. This prevents possible noise on the analog input activating the device accidentally.</p> <p>For factory selected digital control (...-D#-C5S): If parameter <i>Control mode</i> is set for digital control by factory, the setpoint threshold for activating the device connected to pin 5 is any value > 0.</p> <p>Note: If the instrument is forced into Valve Safe State, the digital output is not affected, so a (n.c.) shut-off valve connected to pin 5 will not close when the (n.c.) controller is in Valve Safe State'</p> <p>Make sure to use 24 Vdc power supply corresponding to the shut-off valve specifications.</p>
COI	<p>Digital output, high/low switch via remote parameter (e.g. for shut-off valve control) Pin 5 is pulled down to 0 Vdc when writing value 1 to parameter <i>IO switch status</i>, this is undone by writing value 0.</p> <p>A device connected to pin5 (e.g. a shut-off valve) can be activated/deactivated by writing parameter <i>IO switch status</i>.</p> <p>Note: If the instrument is forced into Valve Safe State, the digital output is also affected, so a (n.c.) shut-off valve connected to pin 5 will be closed when the (n.c.) controller is in 'Valve Safe State'.</p> <p>Make sure to use 24 Vdc power supply corresponding to the shut-off valve specifications.</p>

Code	Description
D9E	<p>Digital frequency output, measure Measurement value is translated to a frequency within given frequency range.</p> <p>The default frequency range to represent 0...100% flow is 0...10000 Hz. Any other frequency range must be specified on order.</p>
F9B	<p>Digital pulse output, batch counter Pin 5 is pulled down to 0Vdc when a given batch size is reached (during a given pulse length).</p> <p>By default, a pulse is given at each 1x the <i>Counter unit</i> batch value, with a pulse length of 1 second. For instance, when <i>Counter unit</i> is set to '1n', a pulse is given each time 1 In has passed through the instrument. An alternative pulse length must be specified on order.</p> <p>Provide a pull-up resistor of 5...10 kOhm to create 15...24 Vdc at pin 5 (according to the applicable hook-up diagram).</p>
I3C	<p>Digital input, controller mode valve close Valve closes when pin 5 is connected to 0 Vdc.</p> <p>This option switches between the default <i>Control mode</i> and mode 'Valve Close' (value 3). When the default <i>Control mode</i> is digital, the default value is 0 (bus/RS-232), when the default <i>Control mode</i> is analog, the default value is 1 (Analog input).</p>
I8C	<p>Digital input, controller mode valve purge Valve is fully opened when pin 5 is connected to 0 Vdc.</p> <p>This option switches between the default <i>Control mode</i> and mode 'Valve Fully Open' (value 8). When the default <i>Control mode</i> is digital, the default value is 0 (bus/RS-232), when the default <i>Control mode</i> is analog, the default value is 1 (Analog input).</p>
I1R	<p>Digital input, reset counter The counter resets when pin 5 is connected to 0 Vdc.</p>
I2R	<p>Digital input, reset alarm The alarm resets when pin 5 is connected to 0 Vdc.</p>



***) Notes regarding controller options:**

- A controller output option (A1V, B1V or B2V) can only be installed in combination with controller mode A or D (controller enabled, see model key).
- If the controller is enabled, the M8 connector can always be used to control a Bronkhorst® valve (through pin 3).
- Although it is theoretically possible to have 3 controller options installed, no more than 1 signal should be used at any time.

2 Installation

This chapter describes the steps to take in order to prepare the **ES-FLOW™ 1xxl** for first time use.

2.1 Functional properties

Before installing the **ES-FLOW™ 1xxl**, check if the functional properties match your requirements. The ES-FLOW™ Brochure provides general technical specifications, specific technical data can be found on the serial number label and in the purchase order.

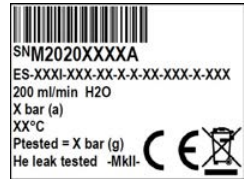

- Flow/pressure rate(s)
- Media to be used in the instrument
- Upstream and downstream pressure(s)
- Ambient temperature
- Input and output signal



*Bronkhorst® instruments are pressure tested to 1.5 times the requested pressure rating and outboard leak tested to at least $2 * 10^{-9}$ mbar l/s Helium. The tested pressure is specified on the serial number label. If the serial number label is missing or if the specified pressure is insufficient, the instrument must not be used and should be returned to the factory.*

Before installation, make sure that the tested pressure is in accordance with the safety factor of your application. The tested pressure must always be higher than the maximum operating pressure.

2.2 Mounting

2.2.1 Location in fluid system

Gas bubbles in the liquid can lead to measurement errors. In general, the instrument should be mounted in a pipe segment where gas bubbles cannot accumulate. The image to the right shows the preferable mounting locations.

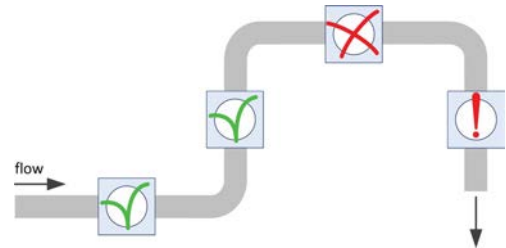

For [hygienic applications](#) some additional recommendations apply (see further).



- In general, the best location is a horizontal pipe segment or a segment where the fluid direction is upward.



- Gas might accumulate in the horizontal segment if it is followed by a downward segment. Do not mount the instrument in a location like this.



- Mounting in a downward pipe segment with an open end is strongly dissuaded, especially if the pipe diameter is 1/2" or more. Gravity might let the segment run empty; depending on the specific system dimensions and the viscosity of the metered fluid, this effect might be stronger or weaker.
- If the instrument is part of a closed fluid system, mounting the instrument in a downward pipe segment is not preferable, but may be considered if other mounting locations are problematic.



To minimize the risk of gas inclusion by cavitation, the preferred location to install a control valve is downstream from the instrument, the preferred location for a pump is upstream.



To prevent damage to the internal electronics, make sure the temperature inside the instrument housing does not get above 60 °C. If necessary, take appropriate heat dissipation measures, especially if the instrument is operated inside an enclosure (e.g. a control cabinet).

2.2.2 Orientation



- In [hygienic applications](#), the **ES-FLOW™ 1xxl** should be mounted in such a way that it allows self-draining (see further).
- To prevent liquid from pooling on the display surface, the instrument should not be mounted with the display surface facing up.
- Other than that, the instrument has no preferred mounting orientation.



Note that the connection between the measuring tube and the electronics housing is fixed; the housing cannot be rotated to get a better view of the display. Its orientation can only be altered by repositioning the entire instrument.



On models starting from MkII, the flow direction and display orientation can be adjusted at the factory, for which the instrument has to be returned. Contact your Bronkhorst representative for more information and arrangements.

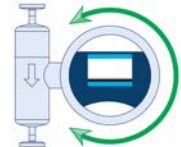

2.2.3 Hygienic applications



In order to comply with the 3-A Sanitary Standards, the **ES-FLOW™ 1xxl** should be mounted in a location where its exterior cannot come into direct contact with food substances and/or the product contact surfaces of their packaging material.



To allow self-draining, mount the **ES-FLOW™ 1xxl** vertically or with a minimum inclination of 10°, with the normal flow going upward (note the FLOW arrow on the instrument).

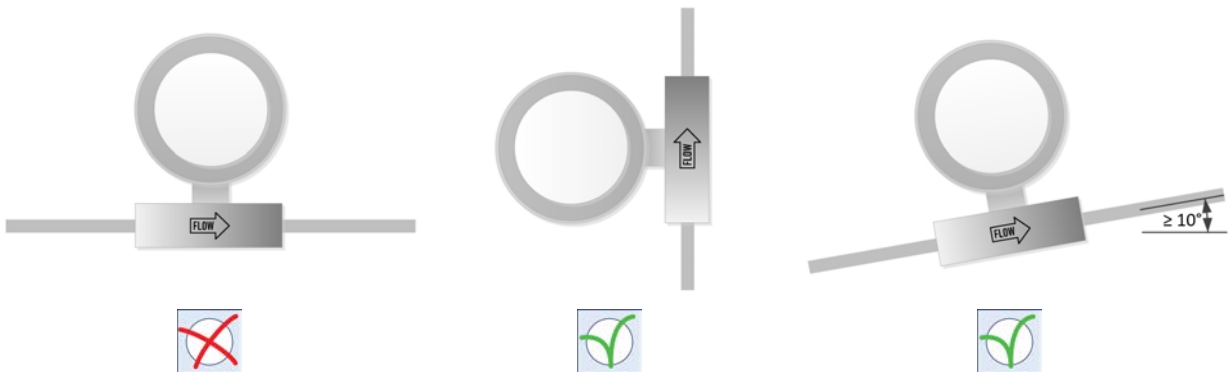

2.3 Fluid connections

The FLOW arrow on the measuring tube indicates the normal flow direction. For normal use, install the **ES-FLOW™ 1xxl** in the process line, in accordance with the direction of the FLOW arrow. For bi-directional measuring, install the instrument in the direction in which the highest flow will be measured (if applicable). When deciding which direction to install the instrument in, take into account that the measuring range in the reverse direction is approximately 73% of the full scale range (whereas the instrument can measure 131% FS in the normal direction).

Tighten fittings according to the instructions of their manufacturer.



Check the fluid system for leak tightness after any modification and before applying full operating pressure, especially when using hazardous media (e.g. toxic or flammable).

2.4 Electrical connections

The **ES-FLOW™ 1xxl** is equipped with one or more electrical connection ports. The image to the right shows the locations of the different ports (the actual presence and appearance of ports might be different, depending on the ordered fieldbus interface and instrument type):

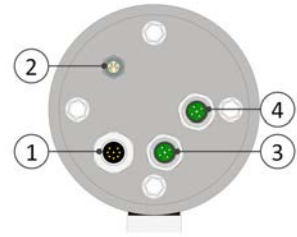

1. Standard connection port, 8-pin M12 male
2. Connection port for actuator output, 4-pin M8 female
3. Fieldbus connection port, 5-pin M12 male/female (optional, fieldbus dependent)
4. Fieldbus connection port, 5-pin M12 male/female (optional, fieldbus dependent)

See sections [Model key](#) and [Functional properties](#) for configurable and installed options respectively.



Upon delivery, all connection ports are capped. To maintain the original ingress protection rating, do not remove the caps of unused connectors.

- Electrical connections must be made with standard cables or according to the applicable [hook-up diagram](#).
- When using self-assembled cables, follow the guidelines provided by the connectors' manufacturer.
- For use in a fieldbus system, follow the instructions of the cable supplier for the according fieldbus system.
- Make sure that the power supply is suitable for the power ratings as indicated on the serial number label (see [model key](#)) or in the technical specifications, and that double or reinforced insulation is used for the power supply.
- Before powering up, make sure all required cabling is properly connected.
- Before each use, inspect cabling and connectors for damage.



Never power the instrument simultaneously from **two different power sources** (e.g. fieldbus and Plug-in Power Supply). Doing so will irreversibly damage the printed circuit board and the instrument will have to be repaired before it can be used.



In order to be able to comply with all applicable guidelines and regulations, it is essential that electrical connections be made by or under supervision of a qualified electrician.



- The equipment described in this document contains electronic components that are susceptible to **electrostatic discharge**.
- When working on the electrical installation, take appropriate measures to prevent damage as a result of electrostatic discharge.



The **CE mark** on the equipment indicates that it complies with requirements imposed by the European Union, including **electromagnetic compatibility (EMC)**.

EMC can only be guaranteed by applying appropriate cables and connectors or gland assemblies:

- Cable wire diameters must be sufficient to carry the supply current and minimize voltage loss.
- When connecting the product to other devices, ensure that the integrity of the shielding remains uncompromised; use shielded cables and connectors where possible and/or required.
- Preferably use the supplied cables (if applicable) to make electrical (signal) connections to and between the supplied components. These cables are shielded, have the required wire diameter, and loose ends (if applicable) are marked to facilitate correct connection.

If not all requirements for proper shielding can be met (for example, because a component is not equipped with shielded connectors), take the following measures to ensure the best possible shielding:

- Keep cable lengths at a minimum.
- Route cables as closely as possible alongside metal structures or components.
- Ensure all electrical components are grounded to earth.

When in doubt about the shielding of your cabling and/or electrical connections, contact your Bronkhorst representative.

2.5 Communication interface

Check if the default network settings match the configuration of the fieldbus system (if applicable). If necessary, the default settings can be overruled by changing the appropriate parameters (see [Network configuration](#)).

3 Operation

3.1 Powering up and powering down



To maintain control of the fluid system and ensure a safe situation, it is recommended to turn on power before applying fluid pressure and to switch off power only after the fluid system is depressurized.



When pressurizing, prevent pressure shocks by gradually bringing the fluid system to the required operating pressure.



After powering up, the control valve will act according the last known setpoint. When setpoint is 0, this means the valve closes (normally open) or stays closed (normally closed). The valve stays closed until the instrument receives a new valid setpoint from the active setpoint source.

3.2 First use



Bronkhorst does the utmost to ensure that you receive a clean product. This does not, however, relieve the end user of the responsibility to ensure that the instrument and the system in which it is incorporated meet (hygiene) requirements that apply to the intended use of the instrument. The responsibility for cleaning the equipment to meet such requirements lies exclusively with the end user.



Before starting measurement and control, make sure to remove gas from the fluid system by flushing all fluid lines with the process fluid at a high flow rate.



For instruments with a control function, the highest possible flow rate is ensured by giving setpoint = 100% or using special [Control mode](#) = 8 (valve fully open). Control mode 8 bypasses the PID controller, which is particularly useful when having the ES-FLOW™ 1xxl set to a low capacity flow range.

3.3 User interface







The screen representations used in this manual serve to illustrate functionality and do not necessarily depict actual process conditions.

The image to the right shows the screen display, immediately after powering up. The following screen areas can be distinguished:

1. Top line
2. Measure readout
3. Custom readout 1 (only for instruments with control function)
4. Custom readout 2

The navigational buttons have the following functionality:

- 
 - Enter selected menu
 - Enter edit mode
 - Confirm selection/changes
- 
 - Navigate up in menu
 - Change character or list item
- 
 - Navigate down in menu
 - Change character or list item
- 
 - Return to previous menu
 - Leave edit mode without making changes
 - Select display info

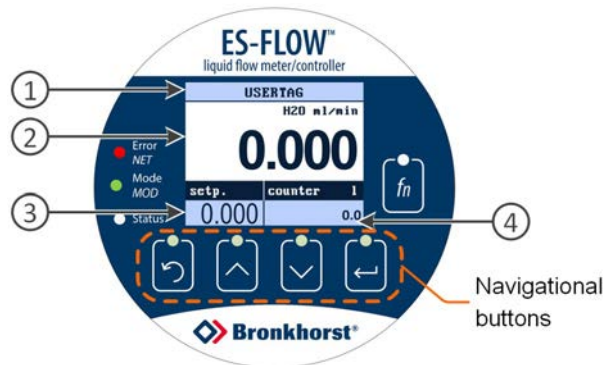

The communication status of the instrument can be monitored with the three LEDs to the left of the screen. See [LED indications](#) for a description of the possible indications.

A multifunctional switch (fn) to the right of the screen can be used to start several functions without having to enter the menu (see [Multifunctional switch](#)).



3.3.1 Main screen functions

3.3.1.1 Unlocking buttons

The switch lock function prevents accidental activation of the user interface (e.g. by cleaning the instrument and/or its environment with a hose or high-pressure cleaner). The lock is activated after a period of inactivity (lock time; 60 seconds by default), after which the individual tip buttons are disabled. The buttons can be unlocked by pressing and holding and for a couple of seconds (unlock time; default: 4 seconds).

The switch lock properties can be edited in the *Settings* menu.

3.3.1.2 Selecting display information

The *Custom readout 2* area can show different parameters. Depending on the instrument type, the following parameters may be available (editable parameters are marked with an *):

- setpoint*
- percentage reading
- actuator/valve percentage
- counter*
- alarm*
- capacity
- temperature
- density
- instrument*

To change the displayed parameter, press from the main screen. Cycle through the available parameters by pressing the button repeatedly.



3.3.1.3 Selecting screen area

Depending on the instrument type and the settings of the readout and control unit, none, one or both of the custom readout areas can display an editable parameter. If an area contains an editable parameter, it can be selected and edited in place. Selection is made visible by a red line above the concerning area.

- To cycle through the editable screen areas, press or repeatedly
- To enter edit mode for the selected area, press
- When edit mode is active, press at any time to leave edit mode without making changes

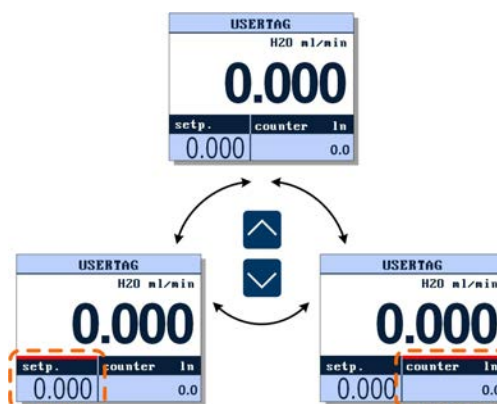

3.3.1.4 Editing setpoint



- The setpoint of a controlling instrument can be changed if the parameter is displayed in the custom readout area.
- Instruments without a control function have no editable setpoint and can only be monitored (Custom readout 1 not available).

If the setpoint is configured to be entered as a character string, follow these steps to change its value:

1. Select a readout area that displays the setpoint:
2. Press to enter edit mode (the first character position is highlighted):
3. Press or to select the required character:
4. Press to advance to the next character position:



On confirmation of the last digit, the entered value is stored and edit mode is left (whereupon the character highlight is removed).

If the setpoint is configured to be entered stepwise, follow these steps to change its value:

1. Select a custom readout area that displays a setpoint:
2. Press to enter edit mode (the current value is highlighted):
3. Press or to change the parameter value (hold the button to scroll fast):
4. Press to store the current value and leave edit mode:



The setpoint input method (string or step-wise) can be set in the [Settings](#) menu (Settings > Setup > Customize > Setpoint)

3.3.1.5 Resetting counter

1. In the main screen, select the *Custom readout 2* area:
2. Press to enter edit mode:
3. Press or to change the value to 'yes':
4. Press to confirm the selected option and reset the counter:



3.3.1.6 Resetting alarm



Before resetting the alarm, be sure to eliminate the cause. Resetting the alarm without changing the conditions that caused it will re-activate the alarm immediately.

When an alarm occurs, a message blinks in the top line of the main screen. If the alarm is configured to be reset automatically, the blinking stops as soon as the alarm conditions no longer apply. If the alarm is configured to be reset manually, follow these steps to reset it:



1. Custom readout 2 area is selected automatically:
2. Press **←** to enter edit mode:
3. Press **↑** or **↓** to change the value to 'yes':
4. Press **←** to confirm the selected option and reset the alarm:



3.3.2 Menu navigation

The configurable parameters of the instrument and settings of the readout and control unit are organized in a menu structure.

Items

Menus can contain items of 3 different types:

Sub menu

An arrow pointing to the right indicates a sub menu



Parameter with list selection

An arrow pointing down indicates a parameter that can be changed by selecting a value from a list



Character string parameter

- First line: unit (if applicable)
- Second line: current parameter value



Not all parameters can be edited; some parameter values are protected, or display a value that is linked to (the value of) another parameter:

Normal display

Parameter can be edited







Dimmed

Parameter is read-only



Navigation

- Inside menus and sub menus, the selected item is highlighted in red
- Press  or  to navigate to the required menu item
- Arrows pointing up and/or down in the top line indicate the menu contains more items than can be displayed.
- Press  to enter the selected sub menu or to enter edit mode
- Press  to return to the previous screen or menu or to leave edit mode without making changes

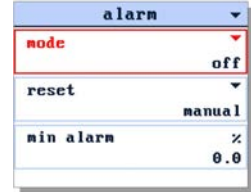

3.3.2.1 Password protection

1. By default, some items are accessible only after entering a password:
2. Enter the password (if the password contains less than 8 characters, fill the remaining positions with spaces):
3. After entering 8 characters, the password is validated. If the password is correct, the selected function is displayed:
4. If the password is incorrect, access is denied:

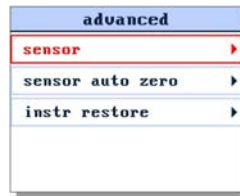
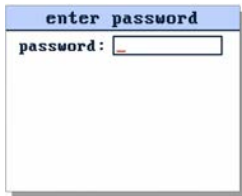





The default password is 'abc' (without quotes) and is case sensitive.



To avoid unauthorized access, change the default password immediately after installation. See [Changing password](#) for instructions.

3.3.2.2 Editing string

1. Select the parameter to be edited:
2. Press  to enter edit mode (the first character position is highlighted):
3. Press  or  to select the required character/digit:
4. Press  to advance to the next character position:

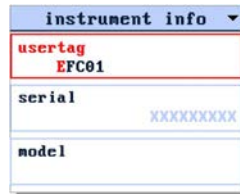

On confirmation of the last character/digit, the entered value is stored and edit mode is left (whereupon the character highlight is removed).

3.3.2.3 Editing list selection

1. Select the parameter to be edited:
2. Press **↵** to enter edit mode (the selected value is highlighted):
3. Press **↑** or **↓** to scroll through the available options:
4. Press **↵** to confirm the selected option and leave edit mode (the highlight is removed):

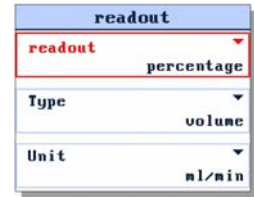
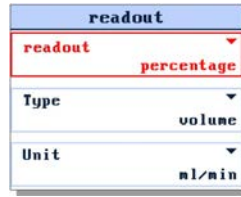
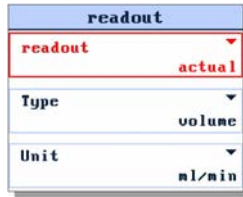
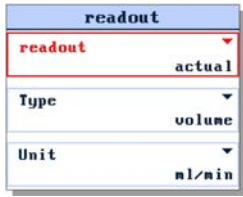

3.3.3 Settings menu



Before the Settings menu can be entered, it may need to be enabled using the [Security](#) menu.

The Settings menu provides access to the user configurable instrument parameters, and contains settings for customizing display behavior of the readout and control unit. The menu is divided into the following sections (available as sub menus):

Sub menu	Description
Readout	Readout settings and fluid selection
Controller	Instrument controller characteristics
Counter/totalizer	Counter and totalizer settings
Alarm	Alarm settings
Setup	Device identification, display customization and bus configuration
Advanced	Sensor filter settings and special functions

1. Start in the main screen:
2. Press **↵** to enter the Settings menu:



3.3.3.1 Readout

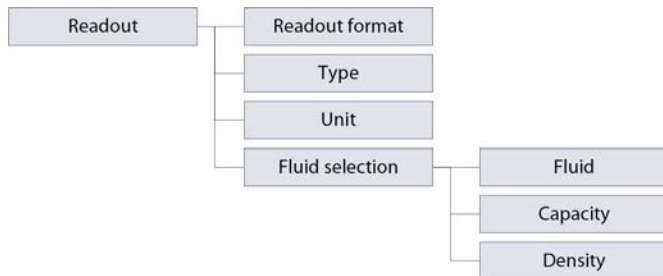

In the *Readout* sub menu, the following parameters can be edited:

Parameter	Description	Supported values
Readout format	Display format of measured value in main screen	<ul style="list-style-type: none"> • actual • percentage
Type*	Measurement type Note: value 'mass' can only be selected if parameter <i>Density</i> > 0	<ul style="list-style-type: none"> • volume • mass
Unit*	Measurement unit	Depending on selected measurement type
Fluid	Selected (metered) fluid	As ordered
Capacity	Maximum readout/control value (100%) for selected fluid	As ordered
Density*	Density of the selected fluid in kg/m ³ Note: this is a fixed reference value, which is used to calculate mass flows	0.000...99999.999



*) Not available on ES-FLOW™ models before Mk II.

3.3.3.2 Controller



The Controller sub menu is only available if the control function of the instrument is enabled. This setting is part of the instrument configuration at the factory.



Control characteristics are optimized during production. These parameters should only be changed if absolutely necessary, and only by or under the supervision of trained service personnel.

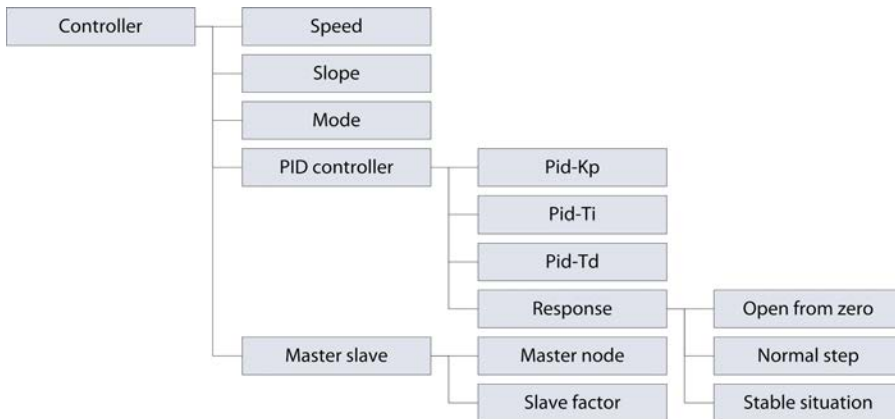

In the *Controller* sub menu, the following parameters can be edited:

Parameter	Description	Supported values
Speed	Controller speed factor	0.001...99.999
Slope	Controller adjustment speed	0.0...3000.0 seconds
Mode*	Control mode	see table below
Pid-Kp	PID controller proportional action	
Pid-Ti	PID controller integration action	
Pid-Td	PID controller differentiation action	
Open from zero	Open from zero response	0...255
Normal step	Normal step response	0...255
Stable situation	Stable situation response	0...255
Master node*	Node address of master instrument	0...128
Slave factor**	Percentage of measurement value of master instrument	0...100.0%

*) The following control modes are available:

Value	Description
rs232	Normal operation via RS-232
bus/rs232	Normal operation via fieldbus or RS-232
analog input	Normal analog operation
setpoint 0 perc.	Setpoint set to 0%
setpoint 100 perc.	Setpoint set to 100%
control idle	Controller disabled, valve frozen in current position
actuator 0 perc.	Controller disabled, valve closed
actuator 100 perc.	Controller disabled, valve fully open
actuator steering	Controller disabled, valve opening equal to setpoint (percentage)
fb slave	Acting as slave of other instrument on FLOW-BUS
analog slave	Acting as slave of other instrument on analog input
fb ana slave	Acting as slave of other instrument on FLOW-BUS, slave factor set by analog input signal

**) The *Master slave* item is only available if one of the slave control modes is selected. Availability of *Master node* and *Slave factor* depends on the selected mode:

Control mode	Master node	Slave factor
fb slave	✓	✓
analog slave		✓
fb ana slave	✓	

See also [Master/slave configuration \(FLOW-BUS\)](#) for more information about setting up a master/slave relationship between instruments.

3.3.3.3 Counter/totalizer

Bronkhorst® flow meters have a built-in counter function, which can be used to monitor and/or control the amount of media flowing through the instrument. The flow can be stopped or changed when a certain limit is reached. Until the counter is reset, the counter setpoint overrides the regular setpoint.

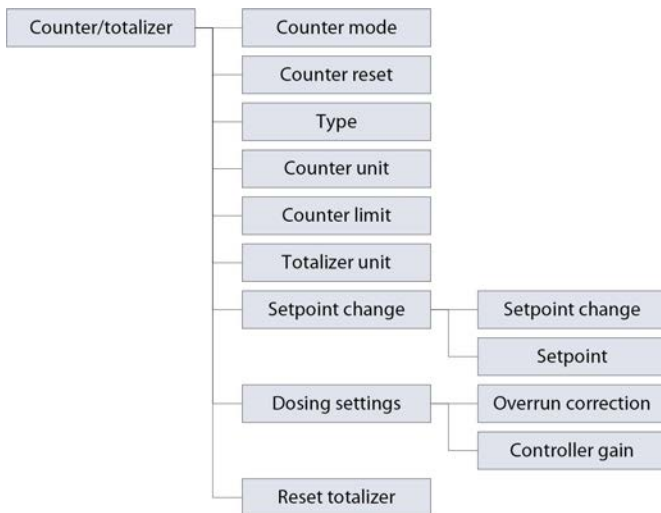

- Some menu items are not available on ES-FLOW™ models before Mk II.
- On models before Mk II, the names of some menu items differ slightly from the descriptions below, but they are still easily recognizable.

The *Counter* sub menu provides the following parameters and functions:

Parameter	Description	Supported values
Counter mode	Selected counter mode	<ul style="list-style-type: none"> off up to limit up
Counter reset	Reset method	<ul style="list-style-type: none"> automatic manual
Type*	Measurement type Note: changing this setting will reset both the counter and the totalizer	<ul style="list-style-type: none"> volume mass
Counter unit*	Measurement unit for the counter	Depending on selected measurement type
Counter limit	Counter limit or batch size	0...99999999.999
Totalizer unit*	Measurement unit for the totalizer	Depending on selected measurement type
Setpoint change	Specifies whether or not to change setpoint after reaching counter limit	<ul style="list-style-type: none"> yes no
Setpoint	New setpoint after reaching counter limit (until counter reset)	Setpoint range
Overrun correction*	Prevents batch size overshoot by stopping flow before reaching configured batch size (<i>Counter limit</i>) <ul style="list-style-type: none"> higher value: faster correction, less dosing cycles needed lower value: slower correction, more dosing cycles needed 	0.000...1.000
Controller gain*	Prevents batch size overshoot by reducing flow when approaching configured batch size (<i>Counter limit</i>) <ul style="list-style-type: none"> default value: 10 higher value: shorter dosing time, more overshoot lower value: longer dosing time, less overshoot 	0 (disabled) 1.000...99999.999
Reset totalizer*	Resets the totalizer	



*) Not available on ES-FLOW™ models before Mk II.

3.3.3.4 Alarm

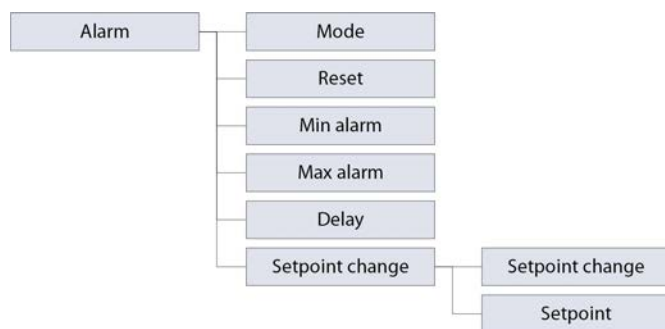

In the *Alarm* sub menu, the following parameters can be edited:

Parameter	Description	Supported values
Mode	Alarm type	<ul style="list-style-type: none"> • off • min/max • response • power-up
Reset	Reset method; reset alarm automatically if alarm conditions no longer apply, or manually via the user interface	<ul style="list-style-type: none"> • automatic • manual
Min alarm	Minimum limit	0...100%
Max alarm	Maximum limit	0...100%
Delay	Number of seconds to wait before triggering alarm action (after alarm situation was activated)	0...255
Setpoint change	Specifies whether or not to change setpoint after an alarm situation is activated	<ul style="list-style-type: none"> • yes • no
Setpoint	New setpoint until alarm reset	Setpoint range

3.3.3.5 Setup

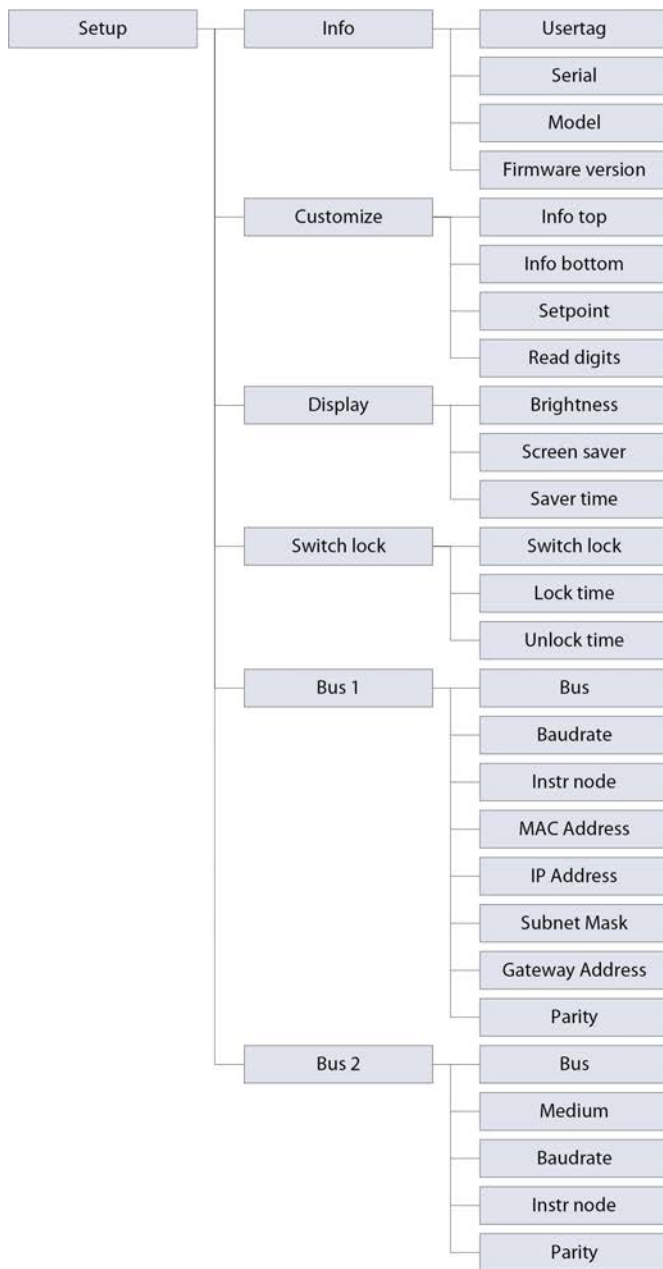

The following parameters are available in the *Setup* sub menu:

Parameter	Description	Supported values
Usetag	Custom instrument name	text (16 positions)
Serial	Instrument serial number	n/a (read only)
Model	Instrument model number	n/a (read only)
Firmware version	Firmware version	n/a (read only)
Info top	Information to show in the top line of the display	<ul style="list-style-type: none"> • usertag • serial number
Info bottom	Information to show in the <i>Custom readout 2</i> area	<ul style="list-style-type: none"> • setpoint • valve • disabled
Setpoint	Specifies if the setpoint is edited as digits or step-wise	<ul style="list-style-type: none"> • cursor • step
Read digits	Number of digits displayed in the measure readout area (including decimal places)	3...5
Brightness	Screen brightness	0...9
Screen saver	Enable or disable screen saver	<ul style="list-style-type: none"> • dimmer • off
Saver time	Number of minutes of inactivity before screen saver becomes active	1...99
Switch lock	Enable or disable switch lock	<ul style="list-style-type: none"> • enabled • disabled
Lock time	Number of seconds of inactivity before switches are locked	0...600
Unlock time	Number of seconds to hold buttons to unlock switches	2...100
Bus (Bus1)	Fieldbus type	read only
Bus (Bus2)	Fieldbus type	FLOW-BUS, PROPAR, Modbus RTU, Modbus ASCII
Medium (only Bus 2)	Communication type	<ul style="list-style-type: none"> • rs232 • rs485
Baudrate (Bus 1 and 2)	Communication speed	fieldbus dependent
Instr node (Bus 1 and 2)	Primary node address on the fieldbus	fieldbus dependent

3.3.3.6 Advanced



Before the *Advanced* menu can be accessed, it may need to be enabled using the [Security](#) menu. If the *Advanced* menu is disabled, it is not visible in the *Settings* menu.

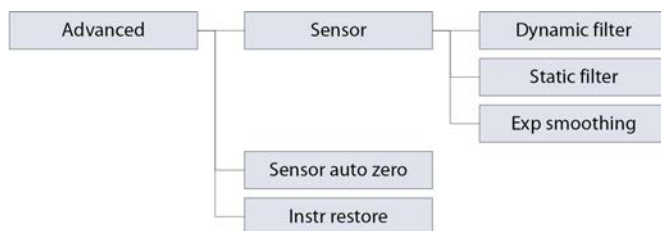

The *Advanced* sub menu provides the following parameters and functions:

Parameter/function	Description	Supported values
Dynamic filter	Dynamic filter	0...1
Static filter	Static filter	0...1
Exp smoothing	Exponential smoothing filter	0...1
Sensor auto zero	Adjust zero point (only for flow meters/controllers)	
Instr restore	Restore factory settings	

3.3.4 Security menu

In the *Security* menu, access to some delicate items can be restricted. The password that is used for password protected items can also be changed here.

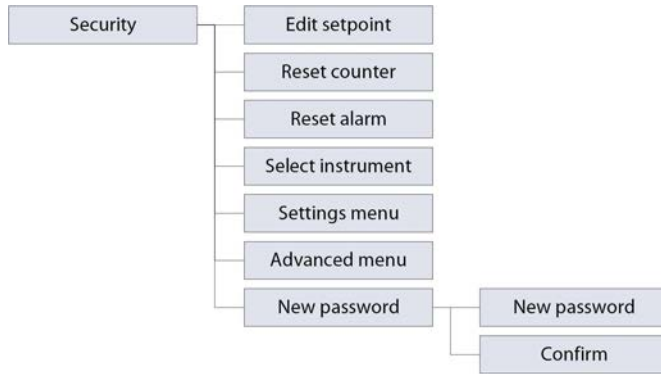

The following items can be restricted:

Item	Description	Factory setting
Edit setpoint	Setpoint edit mode	Enabled
Reset counter	Manually resetting counter in <i>Custom readout 2</i> area	Password
Reset alarm	Manually resetting alarms in <i>Custom readout 2</i> area	Password
Select instrument	Selecting another instrument in fieldbus system (<i>Custom readout 2</i> area)	Enabled
Settings menu	Availability of <i>Settings</i> menu	Enabled
Advanced menu	Availability of <i>Advanced</i> sub menu in <i>Settings</i> menu	Disabled



For each of these items, one of the following access modes can be set:

- **Enabled:** item is available without restrictions
- **Disabled:** item is not available
- **Password:** item is password protected



The password protection of the Security menu itself cannot be removed, nor can the menu be disabled.

To enter the Security menu, follow these instructions:

1. Start in the main screen:
2. Press and hold  and  simultaneously for 5 seconds:
3. Enter the password to enter the *Security* menu:

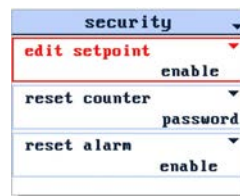
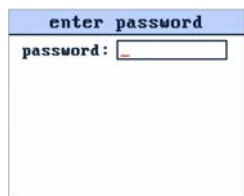

3.3.4.1 Changing password

1. Open the *Security* menu and select the *New password* item:
2. Press **↵** to enter the *New password* sub menu:
3. Press **↵** to enter edit mode and enter the new password:
4. After confirming the last character, select the *Confirm* item:



5. Press **↵** to confirm the new password:



The new password is applied only after confirmation; the password is active throughout the entire readout and control program.

3.3.4.2 Resetting password

If the password is lost (after changing it), it can be reset by entering an encrypted key. This reset key can be obtained by sending a so-called 'bht key' to your Bronkhorst representative. After entering the reset key, the password will be reset to the default value ('abc').

To get a *bht key* from the readout and control unit, follow these instructions:

1. Press **⬆** and **⬇** simultaneously for 5 seconds, until the 'enter password' screen appears:
2. Again, press **⬆** and **⬇** simultaneously for 5 seconds, until the *Reset password* screen appears:
3. Write down the *bht key* and send it to your Bronkhorst representative by e-mail. After validation, you will receive a reset key.



When you have received your reset key, return to the *Reset password* screen and proceed as follows:

4. Enter the reset key:
5. On confirmation of the last character position, the password is reset:
6. Press any key to return to the main readout screen:



3.3.5 LED indications

- (green) Mode/MOD: operation mode indication
- (red) Error/NET: error/warning messages

The tables below list the different LED indications:

● Green		
Pattern	Time	Indication
off	continuous	Power-off or program not running
on	continuous	Normal operation mode
short flash	0.1 sec on, 2 sec off	No bus communication, valves are in safe state
blink	0.2 sec on, 0.2 sec off	Special function mode; the instrument is busy performing a special function (e.g. auto-zero or self-test)
long flash	2 sec on, 0.1 sec off	Configuration mode; on the 5-pin M12 connector, the baud rate is set to 38400 and the bus type to RS-232 FLOW-BUS (ProPar)

● Red		
Pattern	Time	Indication
off	continuous	No error
on	continuous	No liquid in measuring tube OR Pulsating flow rate OR Critical error; the instrument needs servicing before it can be used
short flash	0.1 sec on, 2 sec off	FLOW-BUS Node occupied: re-install instrument PROFIBUS DP No data exchange between master and slave (automatic recovery) Modbus Data is being received or transmitted
blink	0.2 sec on, 0.2 sec off	FLOW-BUS Waiting for communication, check communication settings of all FLOW-BUS devices in the fieldbus setup. Usually the 'last node address' setting of one of the devices is incorrect. PROFIBUS DP Not used Modbus Not used
long flash	2 sec on, 0.1 sec off	FLOW-BUS Not used PROFIBUS DP Requested parameter not available Modbus Not used

● Green and ● red (alternating)		
Pattern	Time	Indication
slow wink	1 sec on, 1 sec off	Alarm indication; minimum/maximum alarm, power-up alarm, limit reached or batch size reached
normal wink	0.2 sec on, 0.2 sec off	Wink mode; by sending a command to the <i>Wink</i> parameter, the instrument flashes its LEDs, so that it can be located in the physical setup
fast wink	0.1 sec on, 0.1 sec off	Selected action started (after releasing the multifunctional switch)

3.3.5.1 Interface status

On instruments with an Ethernet based fieldbus interface, a third LED (bi-color; green and red) indicates the status of the communication interface:

Pattern	Time	EtherCAT®	PROFINET
● off	continuous	Power off or initializing	Interface not (yet) started
● on, green	continuous	Normal operation	Normal operation, application relation established with I/O controller
● blinking, green	0.2 sec on, 0.2 sec off	Pre-operational	Initializing
● blinking, red	0.2 sec on, 0.2 sec off	Invalid state change	Link status OK, no application relation with I/O controller
● on, red	continuous	n/a	No link
● single flash, red	0.2 sec on, 1 sec off	Invalid configuration	n/a
● double flash, red	0.2 sec on, 0.2 sec off, 0.2 sec on, 1 sec off	Communication timeout (e.g. communication cable disconnected)	n/a

3.3.5.2 DeviceNet™



DeviceNet™ instruments have different LED indications altogether, replacing the previously mentioned standard indications.

DeviceNet™ instruments have two bi-color LEDs (green and red), to indicate network and module status:

- /● (green/red) Network status (NET)
- /● (green/red) Module status (MOD)

The tables below list the different LED indications:

Network status		
Pattern	Time	Indication
● off	continuous	Power-off or offline
● on, green	continuous	Online , connected, link OK
● blinking, green	0.5 sec on, 0.5 sec off	Online, not connected; the instrument is online but has no connections to other nodes or is not allocated to a master
● blinking, red	0.5 sec on, 0.5 sec off	Connection timed out
● on, red	continuous	Critical link failure; the device cannot connect to the network

Module status		
Pattern	Time	Indication
● off	continuous	No power
● on, green	continuous	Normal operation mode
● blinking, green	0.5 sec on, 0.5 sec off	Device is in standby mode or configuration is missing, incomplete or incorrect
●/● alternating	0.5 sec green, 0.5 sec red	Self test mode
● on, red	continuous	Critical error; the instrument needs servicing before it can be used

3.3.6 Multifunctional switch

Some special instrument functions can be started manually using the multifunctional switch near the indication LEDs. These functions are available in analog as well as in digital operation mode.

3.3.6.1 Normal operating functions

- In order to access these functions, press and hold the switch while the instrument is in normal operation mode (green LED lit continuously).
- As long as the switch is held, the LEDs show a repeating sequence of patterns, where each pattern indicates a function.
- All patterns in this sequence are continuous.
- Each pattern is shown for a number of seconds; in the table below, the column labeled *Hold time* indicates the time frame during which a pattern is shown.
- To start the required function, release the switch when the LEDs show the associated pattern.

● (green)	● (red)	Hold time	Function
off	off	0...1 sec	No action
off	off	1...4 sec	1. In case of a min/max alarm: reset alarm 2. FLOW-BUS: Auto-install to bus - lets instrument obtain free node address Note: min/max alarm (if any) has to be reset before auto install can be performed.
off	on	4...8 sec	Reset instrument; clear all warnings and error messages and restart the instrument
on	off	8...12 sec	Auto-zero; re-adjust the zero-point of the instrument (flow meters/controllers only)
on	on	12...16 sec	Enable FLASH mode for firmware update: <ul style="list-style-type: none"> • the instrument shuts down and both LEDs are switched off • at the next power-up, the instrument will be active again



- See [Adjusting zero point](#) for background information and instructions on how to adjust the zero point of an instrument.
- Do not adjust the zero point before having taken notice of the instructions.

3.3.6.2 Control mode - readout/change

Reading control mode

- By briefly pressing the switch 2 times within 1 second in normal operation mode, the instrument shows its current control mode with a series of consecutive LED indication patterns.
- The number of flashes corresponds to the current value of parameter *Control Mode* (see [Special parameters](#)).



Step	Pattern	Indication
1	Green	● ● number of flashes indicates the tens of the parameter value
2	Red	● ● number of flashes indicates the units of the parameter value

Examples:

- for value 1 (control mode 'Analog input'), the green LED will flash 0 times and the red LED 1 time
- for value 22 (control mode 'Valve Safe State'), the green and red LED will each flash 2 times

Changing control mode

- By briefly pressing the switch 4 times with intervals of up to 1 second in normal operation mode, the instrument enters a state in which the control mode can be changed.
- This is done in 2 steps, each represented by a LED indication pattern (green or red; see table below).
- The number of flashes corresponds to the available values of parameter *Control Mode* (see [Special parameters](#)).
- At the start of each step, the according LEDs starts flashing fast (0.1 second on, 0.1 second off). By pressing and holding the switch, the associated action is started and the flashing slows (0.5 seconds on, 0.5 seconds off).

Step	Pattern	Maximum flash count	Action
1	Green 	2	set tens of parameter value
2	Red 	9	set units of parameter value

To execute a step, follow these instructions:

- Press and hold the switch (flashing slows)
- To select value 0 (zero), release the switch within 1 second, otherwise:
- Count the number of LED flashes
- Release the switch when the required value is reached
- In case you lose count, keep the switch pressed and wait until the flash count reaches its maximum and restarts

On completion of step 1, the instrument automatically advances to step 2. When both steps have been completed, the instrument returns to its normal operation mode.

If the switch is not pressed within 60 seconds after starting a step, all changes are canceled and the instrument returns to its normal operation mode.





Note that this procedure also sets the [default control mode](#) of the instrument (contrary to changing the control mode digitally).

3.3.6.3 Network settings - readout/change

Reading network settings

- By briefly pressing the switch 3 times with intervals of up to 1 second in normal operation mode, the instrument shows its current node address and baud rate with a series of consecutive LED indication patterns:

Step	Pattern	Indication
1	Green 	number of flashes indicates the tens of the node address
2	Red 	number of flashes indicates the units of the node address
3	Green and red (simultaneous) 	number of flashes indicates the baud rate

Examples:

- for node address 35, the green LED will flash 3 times and the red LED 5 times
- for node address 116, the green LED will flash 11 times and the red LED 6 times





On DeviceNet™ the node address is called MAC ID.

The number of flashes for the baud rate indication is associated with the following baud rates:

Number of flashes (index)	Baud rate					
	FLOW-BUS	Modbus (ASCII/RTU)	PROFIBUS DP	CANopen	DeviceNet™	Ethernet based
0			automatically detected			
1	187500	9600	9600	1000000	125000	100000000
2	400000	19200	19200	800000	250000	
3		38400	45450	500000	500000	
4		56000	93750	250000		
5		57600	187500	125000		
6		115200	500000	50000		
7		128000	1500000	20000		
8		256000	3000000	10000		
9			6000000			
10			12000000			

Changing network settings

- By briefly pressing the switch 5 times with intervals of up to 1 second in normal operation mode, the instrument enters a state in which the node address and baud rate can be changed (non-Ethernet based protocols only; for Ethernet based protocols, network parameters are configured by the fieldbus master and cannot be set on the instrument).
- Changing network parameters with the multifunctional switch is done in 3 steps, each represented by a LED indication pattern (see table below).
- At the start of each step, the according LED(s) start(s) flashing fast (0.1 second on, 0.1 second off). By pressing and holding the switch, the associated action is started and the flashing slows (0.5 seconds on, 0.5 seconds off).

Step	Pattern	Maximum flash count	Action
1	Green 	12	set tens of node address
2	Red 	9	set units of node address
3	Green and red (simultaneous) 	10*	set baud rate index (number of flashes)

*) maximum count depends on the supported baud rates of the fieldbus. See the baud rate table above for supported baud rates and associated indexes.

To execute a step, follow these instructions:

- Press and hold the switch (flashing slows)
- To select value 0 (zero), release the switch within 1 second, otherwise:
- Count the number of LED flashes
- Release the switch as soon as the required value is reached
- In case you lose count, keep the switch pressed and wait until the flash count reaches its maximum and restarts

On completion of a step, the instrument automatically advances to the next step. When all required steps have been completed, the instrument returns to its normal operation mode.

If the switch is not pressed within 60 seconds after starting a step, all changes in the previous steps are cancelled and the instrument returns to its normal operation mode.

3.3.6.4 Disabling multifunctional switch

To prevent unwanted use of the multifunctional switch, it can be disabled through the digital interface using the following procedure:

1. Set parameter *Init reset* to 64
2. Read parameter *IO status*
3. Subtract 8 from the read value
4. Write the new value to parameter *IO status*
5. Set parameter *Init reset* to 82

To re-enable the switch, add 8 to the value of *IO status* in step 3.

3.4 Digital parameters

Each instrument is controlled internally by several digital parameters, most of which can only be accessed using digital communication. Each communication protocol uses its own methods for communicating with instruments and accessing parameters.

FLOW-BUS

Digital Bronkhorst® instruments can be monitored and operated using the free **FlowWare** software tools for Windows. These tools provide a graphical interface to the [ProPar](#) protocol (used by FLOW-BUS), for monitoring and editing parameter values.

The FlowWare toolkit provides functionality for monitoring and operating digital instruments (Bronkhorst FlowSuite, FlowPlot) and selection of the active fluid and configuration of the fieldbus connection (if applicable). For instruments that support the definition and use of multiple fluids, FlowTune™ can be used to define and store fluids in the instrument and select the active fluid.

Digital instrument parameters are made accessible by **FlowDDE**, a Dynamic Data Exchange server (DDE) that handles communication between the instrument and (dedicated) client software in Windows (e.g. FlowPlot). FlowDDE can also be used by other client applications, such as Microsoft Office or custom made software, built with third party development software like LabVIEW or a SCADA platform.



The FlowWare tools and associated documentation can be downloaded from the product pages on the Bronkhorst website:
www.bronkhorst.com/products

Modbus

In a Modbus system instruments can be monitored and operated using third party software as a master device, such as LabVIEW, ModScan, or a Modbus PLC.

CANopen

Instruments in a CANopen system can be monitored and operated using third party software as a master device, such as TIA Portal (by Siemens) or Codesys.

To configure a device, a so-called EDS file (Electronics Data Sheet) can be loaded into the software. The EDS file contains all necessary configuration information to operate the device in a CANopen system, including communication and network configuration, and all available operating parameters with their data types.



An EDS file for Bronkhorst® instruments can be downloaded from the product pages on the Bronkhorst website:
www.bronkhorst.com/products

PROFIBUS DP

Instruments in a PROFIBUS DP system can be monitored and operated using third party software as a master device, such as TIA Portal (by Siemens).

To operate a PROFIBUS DP device, a so-called GSD file (General Station Description) has to be loaded into the software. The GSD file contains all necessary configuration information to operate the device in a PROFIBUS DP system, including all available operating parameters with their data types.



A GSD file for Bronkhorst® instruments can be downloaded from the product pages on the Bronkhorst website:
www.bronkhorst.com/products

PROFINET

Instruments in a PROFINET system can be monitored and operated using third party software as a master device, such as TIA Portal (by Siemens).

To configure a device, a so-called GSDML file (General Station Description Markup Language) can be loaded into the software. The GSDML file contains all necessary information, in XML format, to operate the device in a PROFINET system, including communication and network configuration, and all available operating parameters with their data types.



A GSDML file for Bronkhorst® instruments can be downloaded from the product pages on the Bronkhorst website: www.bronkhorst.com/products

DeviceNet™

Instruments in a DeviceNet™ system can be monitored and operated using third party software as a master device, such as TIA Portal (by Siemens).

To configure a device, a so-called EDS file (Electronics Data Sheet) can be loaded into the software. The EDS file contains all necessary configuration information to operate the device in a DeviceNet™ system, including communication and network configuration, and all available operating parameters with their data types.



An EDS file for Bronkhorst® instruments can be downloaded from the product pages on the Bronkhorst website: www.bronkhorst.com/products

3.4.1 General

This section describes the most commonly used parameters for digital operation of the ES-FLOW™. Descriptions are grouped by category in tables as shown below:

Type	Access	Range	FlowDDE	FLOW-BUS	Modbus
[type]	RW	[x]...[y]	[DDE par]	[Pro]/[Par]	[address]/[register]



In this manual, parameter names are printed in italics (reverted to normal where embedded in italics, like in this tip).

Type

Unsigned char	1 byte unsigned integer (0...255)
Unsigned int	2 byte unsigned integer, MSB first (0...65535)
Unsigned long	4 byte unsigned integer, MSB first (0...4294967295)
Float	4 byte floating point, IEEE 32-bit single precision, MSB first
Unsigned char [x]	x byte text string

Access

R	Parameter value can be read
W	Parameter value can be written
	Parameter is secured and only accepts values if parameter <i>Init Reset</i> is set to 'unlocked' first

Range

Some parameters only accept values within a certain range:

[x]	Minimum value
[y]	Maximum value

FlowDDE

Parameter number within FlowDDE

FLOW-BUS

FLOW-BUS uses the ProPar protocol, where parameters are identified by a unique combination of a process number and a parameter number.



- For more information about setting up a FLOW-BUS network with Bronkhorst® instruments, consult the FLOW-BUS manual (see [Documentation](#)).
- For more information about the ProPar protocol, consult the RS-232 manual (see [Documentation](#)).

Modbus

In the Modbus protocol, parameters are accessed by specifying their unique decimal register number or corresponding PDU address (Protocol Data Unit). The PDU address is the hexadecimal translation of the register number minus 1, e.g. register number 1 corresponds to PDU address 0x0000, register number 11 corresponds to PDU address 0x000A:

[address] Hexadecimal PDU address
[register] Decimal register number

Modbus address blocks are two bytes big. Larger data types use up to 8 subsequent address blocks, resulting in a maximum variable length of 16 bytes. Values longer than the maximum length are truncated.



For more detailed information about setting up a Modbus network with Bronkhorst® instruments, consult the Modbus manual (see [Documentation](#)).

Other interface protocols

Parameter descriptions in this document are based on their availability with FLOW-BUS, Modbus or RS-232 (ProPar) communication. Due to limitations in, for example, memory capacity or communication properties, definition files for other fieldbus systems usually do not make all parameters available.



Not all parameters described in this document are necessarily available with all digital interface types. For information about parameter access and availability for Bronkhorst® instruments in a specific fieldbus network, consult the according [fieldbus manual](#).

3.4.2 Measurement and control**Measure**

Type	Access	Range	FlowDDE	FLOW-BUS	Modbus
Unsigned int	R	0...41942 (65535*)	8	1/0	0x0020/33

This parameter returns a dimensionless representation of the measured flow rate or pressure. The value 32000 corresponds to 100 %, the maximum value corresponds to 131.07 %.



*In case the instrument is prepared for bi-directional measurement, the negative signals with an output range of -73.73...-0.003% are represented by the range of 41943...65535, whereas the positive signals 0...131.07% are still represented by the range of 0...41942. (FlowDDE converts the numbers to negative values automatically).

Setpoint

Type	Access	Range	FlowDDE	FLOW-BUS	Modbus
Unsigned int	RW	0...32000	9	1/1	0x0021/34

This parameter is a dimensionless representation of the required flow rate or pressure. Value 32000 corresponds to 100 %.

3.4.2.1 Secondary outputs**Temperature**

Type	Access	Range	FlowDDE	FLOW-BUS	Modbus
Float	R	-250...500	142	33/7	0xA138...0xA139/41273...41274

This parameter returns the internal temperature in the instrument housing in °C.

3.4.2.2 Advanced measurement and control**fMeasure**

Type	Access	Range	FlowDDE	FLOW-BUS	Modbus
Float	R	-3.4E+38... 3.4E+38	205	33/0	0xA100...0xA101/ 41217...41218

This parameter represents the value of parameter *Measure*, expressed in the selected *Capacity Unit*. Its value is calculated from the dimensionless value of *Measure*, using the fluid set parameters *Capacity 100%* and *Capacity Unit*.

Fsetpoint

Type	Access	Range	FlowDDE	FLOW-BUS	Modbus
Float	RW	0...3.4E+38	206	33/3	0xA118...0xA119/ 41241...41242

This parameter represents the value of parameter *Setpoint*, expressed in the selected *Capacity Unit*. Conversion between *Fsetpoint* and the dimensionless value of *Setpoint* uses fluid set parameters *Capacity 100%* and *Capacity Unit*.

Setpoint Slope

Type	Access	Range	FlowDDE	FLOW-BUS	Modbus
Unsigned int	RW	0...30000	10	1/2	0x0022/35

The value of this parameter represents the time it would take to adjust the setpoint if it were changed from 0 to 100%. This feature can be used to smooth 'nervous' controller behavior, e.g. to reduce setpoint overshoot or undershoot. The supported range corresponds to 0...3000 seconds. Default value = 0.

Example:

If *Setpoint Slope* = 100 it will take 10 seconds to adjust the setpoint if it is changed from 0 to 100%. A setpoint change of 20% will take $(20\%/100\%)*10$ seconds = 2 seconds.

Analog Input

Type	Access	Range	FlowDDE	FLOW-BUS	Modbus
Unsigned int	R	0...65535	11	1/3	0x0023/36

This parameter contains a digital translation of the analog input signal (if applicable).

Valve Output

Type	Access	Range	FlowDDE	FLOW-BUS	Modbus
Unsigned long	RW	0... 16777215	55	114/1	0xF208...0xF209/61961...61962

This parameter represents the controller output signal for control valve operation.

3.4.3 Alarms

Alarm settings are most easily accessible using Bronkhorst FlowSuite, FlowPlot or FlowView or a Bronkhorst® readout and control unit.

The built-in alarm functionality can be used to handle different alarm types:

- system errors and warnings
- min/max alarms
- response alarms
- batch alarms
- master/slave alarms

The alarm type can be set with parameter *Alarm Mode*. When an alarm is activated, the type can be read out using parameter *Alarm Info*. An automatic setpoint change can be set using the parameters *Alarm Setpoint Mode* and *Alarm New Setpoint*. It is also possible to set an alarm delay, to prevent overreaction to small disturbances, using parameter *Alarm Delay Time*. The methods by which an alarm can be reset are controlled by *Reset Alarm Enable*.

Alarm Mode

Type	Access	Range	FlowDDE	FLOW-BUS	Modbus
Unsigned char	RW	0...3	118	97/3	0x0C23/3108

Available modes:

Value	Description
0	Alarm off
1	Alarm on absolute limits
2	Alarm on limits related to setpoint (response alarm)
3	Alarm at power-up(e.g. after power-down)

(On DeviceNet™ instruments, only modes 0 and 1 are available)

Alarm Info

Type	Access	Range	FlowDDE	FLOW-BUS	Modbus
Unsigned char	R	0...255	28	1/20	0x0034/53

This parameter provides information about the event type(s) that triggered an alarm situation. The value is a bitwise summation of the issued alarm types; convert the value to binary to see which types are issued. The following alarm types can be issued:

Bit	Value	Type	Description
0	1	Error	Error flag raised
1	2	Warning	Warning flag raised
2	4	Minimum alarm	<i>Measure</i> < <i>Alarm minimum limit</i>
3	8	Maximum alarm	<i>Measure</i> > <i>Alarm maximum limit</i>
4	16	Batch counter alarm	Batch counter reached its limit
5	32	<ul style="list-style-type: none"> • This bit only: Power-up alarm • If combined with bit 2 or 3: Response alarm 	Alarm possibly caused by a power dip Difference between <i>Measure</i> and <i>Setpoint</i> too big
6	64	Master/slave alarm	Setpoint out of limits (caused by <i>Slave factor</i>)
7	128	Hardware alarm	Hardware error

Alarm Delay Time

Type	Access	Range	FlowDDE	FLOW-BUS	Modbus
Unsigned char	RW	0...255	182	97/7	0x0C27/3112

This value represents the time in seconds the alarm action will be delayed when an alarm limit has been exceeded. This value also delays the alarm off action if an alarm limit is no longer exceeded.
Default value = 0.

Alarm Maximum Limit

Type	Access	Range	FlowDDE	FLOW-BUS	Modbus
Unsigned int	RW	0...32000	116	97/1	0x0C21/3106

Maximum limit for *Measure* to activate the maximum alarm situation (after *Alarm Delay Time*). Range 0...32000 represents 0...100% signal. *Alarm Maximum Limit* must be greater than *Alarm Minimum Limit*.
Default value: 0.

Alarm Minimum Limit

Type	Access	Range	FlowDDE	FLOW-BUS	Modbus
Unsigned int	RW	0...32000	117	97/2	0x0C22/3107

Minimum limit for *Measure* to activate the minimum alarm situation (after *Alarm Delay Time*). Range 0...32000 represents 0...100% signal. *Alarm Minimum Limit* must be smaller than *Alarm Maximum Limit*.
Default value: 0.

Alarm Setpoint Mode

Type	Access	Range	FlowDDE	FLOW-BUS	Modbus
Unsigned char	RW	0...1	120	97/5	0x0C25/3110

Specifies whether or not to change the setpoint after an alarm situation is activated.

Value	Description
0	No setpoint change (default)
1	Change setpoint to <i>Alarm new setpoint</i>

Alarm New Setpoint

Type	Access	Range	FlowDDE	FLOW-BUS	Modbus
Unsigned int	RW	0...32000	121	97/6	0x0C26/3111

New (safe) setpoint during an alarm until reset. Range 0...32000 represents 0...100% setpoint.
Default value: 0

Reset Alarm Enable

Type	Access	Range	FlowDDE	FLOW-BUS	Modbus
Unsigned char	RW	0...15	156	97/9	0x0C29/3114

Available reset methods. The value is a bitwise summation of the enabled methods; convert the value to binary to see which methods are enabled.
Default value: 15 (all bits/methods enabled)

The following methods are supported:

Bit	Value	Description
0	1	By hardware switch (if present)
1	2	Externally (obsolete)
2	4	By parameter <i>Reset</i>
3	8	Automatically (when alarm conditions no longer apply)

3.4.4 Counter and totalizer

- Counter settings are most easily accessible using Bronkhorst FlowSuite, FlowPlot or FlowView or a Bronkhorst® readout and control unit.
- When the instrument is powered down, it remembers the state of the counter. If the counter is active when the instrument is powered down, it is activated when powered up and then continues to count from the value at the time of power down.

Counter Mode

Type	Access	Range	FlowDDE	FLOW-BUS	Modbus
Unsigned char	RW	0...2	130	104/8	0x0D08/3337

Available modes:

Value	Description
0	Counter off (default)
1	Counting up continuously
2	Counting up until limit reached (set by <i>Counter Limit</i>)

Counter Unit

Type	Access	Range	FlowDDE	FLOW-BUS	Modbus
Unsigned char[4]	RW	see table below	128	104/7	0xE838...0xE839/59449...59450

This parameter contains the name of the counter readout unit.

Counter Unit supports the following values:

Mass	Normal volume (1.01325 bar(a), 0 °C)	Standard volume (1.01325 bar(a), 20 °C)	Custom volume (Capacity Unit Pressure, Capacity Unit Type Temperature)
ug, mg, g, kg	uln, mln, ln, mm3n, cm3n, dm3n, m3n	uls, mls, ls, mm3s, cm3s, dm3s, m3s	ul, ml, l, mm3, cm3, dm3, m3



Parameter Density (FlowDDE ID 170) is used to calculate Custom volume.

Counter Value

Type	Access	Range	FlowDDE	FLOW-BUS	Modbus
Float	RW	0... 10000000	122	104/1	0xE808...0xE809/59401...59402

Current counter value in units selected with parameter *Counter Unit*.

Counter Limit

Type	Access	Range	FlowDDE	FLOW-BUS	Modbus
Float	RW	0...9999999	124	104/3	0xE818...0xE819/59417...59418

Counter limit/batch size in units selected with parameter *Counter Unit*.
Default value: 0.

Counter Setpoint Mode

Type	Access	Range	FlowDDE	FLOW-BUS	Modbus
Unsigned char	RW	0...1	126	104/5	0x0D05/3334

Specifies whether or not to change the setpoint after reaching the counter limit.

Value	Description
0	No setpoint change (default)
1	Change setpoint to <i>Counter new setpoint</i>

Counter New Setpoint

Type	Access	Range	FlowDDE	FLOW-BUS	Modbus
Unsigned int	RW	0...32000	127	104/6	0x0D06/3335

New (safe) setpoint when a counter limit is reached until reset. Range 0...32000 represents 0...100% setpoint.
Default value: 0

Reset Counter Enable

Type	Access	Range	FlowDDE	FLOW-BUS	Modbus
Unsigned char	RW	0...15	157	104/9	0x0D09/3338

Available reset methods. The value is a bitwise summation of the enabled reset methods; convert the value to binary to see which methods are enabled.

Default value: 7 (bits/methods 0, 1 and 2 enabled)

The following methods are supported:

Bit	Value	Description
0	1	By hardware switch (if present)
1	2	Externally (obsolete)
2	4	By parameter <i>Reset</i>
3	8	Automatically (e.g. when counter value is reset)

Totalizer Unit

Type	Access	Range	FlowDDE	FLOW-BUS	Modbus
Unsigned char[4]	RW	See parameter <i>Counter Unit</i>	394	104/18	0xE890...0xE891/59537...59538

This parameter contains the name of the totalizer readout unit.

Totalizer Value

Type	Access	Range	FlowDDE	FLOW-BUS	Modbus
Float	RW	0... 10000000	393	104/17	0xE888...0xE889/59529...59530

Current totalizer value in units as selected with parameter *Totalizer Unit*.

3.4.5 Network configuration



Changes made to the network settings will **not** be restored by a factory reset.

Default configuration

Network configuration is done ex factory as ordered. The table below shows the supported configurations for the available interface protocols (default settings are printed in bold):

Protocol	ProPar (RS-232)	FLOW-BUS (RS-485)	Modbus (RTU/ASCII)	PROFIBUS DP	CANopen	DeviceNet™
Address	3	3...125	1...247	0...126	1...127	0...63
Baud Rate	9600 19200 38400 57600 115200 230400 460800	187500 400000	9600 19200 38400 56000 57600 115200 128000 256000	(autodetect) 9600 19200 45450 93750 187500 500000 1500000 3000000 6000000 12000000	10000 20000 50000 125000 250000 500000 800000 1000000	125000 250000 500000
Parity	0	0	0, 1, 2	2	0	0

Network configuration for Ethernet based fieldbus types is done automatically via the Ethernet protocol.

Communication via fieldbus connector (RS-485)

Use the following parameters to configure the instrument for communication through the fieldbus connector (5-pin M12):

Fieldbus1 Address

Type	Access	Range	FlowDDE	FLOW-BUS	Modbus
Unsigned char	RW 	0...255	199	125/10	0x0FAA/4011

Fieldbus1 Baud Rate

Type	Access	Range	FlowDDE	FLOW-BUS	Modbus
Unsigned long	RW 	0...1.0E10	201	125/9	0xFD48...0xFD49/64841...64842

Fieldbus1 Parity

Type	Access	Range	FlowDDE	FLOW-BUS	Modbus
Unsigned char	RW 	0...2	335	125/12	0x0FAC/4013

The following values are supported:

Value	Description
0	No parity
1	Odd parity
2	Even parity

Communication via standard connector (RS-232/RS-485)

Use the following parameters to configure the instrument for communication through the 8-pin M12 connector:

Fieldbus 2 Address

Type	Access	Range	FlowDDE	FLOW-BUS	Modbus
Unsigned char	RW 	0...255	309	124/10	0x0F8A/3979

Fieldbus 2 Baud Rate

Type	Access	Range	FlowDDE	FLOW-BUS	Modbus
Unsigned long	RW 	0...1.0E10	310	124/9	0xFC48...0xFC49/64585...64586

Fieldbus 2 Parity

Type	Access	Range	FlowDDE	FLOW-BUS	Modbus
Unsigned char	RW 	0...2	336	124/12	0x0F8C/3981

The following values are supported:

Value	Description
0	No parity
1	Odd parity
2	Even parity

3.4.6 Fluid**Fluid Name**

Type	Access	Range	FlowDDE	FLOW-BUS	Modbus
Unsigned char[10]	RW 	-	25	1/17	0x8188...0x818C/33161...33165

This parameter contains the name of the process fluid.

Capacity 100%

Type	Access	Range	FlowDDE	FLOW-BUS	Modbus
Float	RW 	1E-10... 1E+10	21	1/13	0x8168...0x8169/33129...33130

This parameter represents the 100 % readout/control value (span), expressed in the selected *Capacity Unit*.

Capacity Unit

Type	Access	Range	FlowDDE	FLOW-BUS	Modbus
Unsigned char[7]	RW 	see below	129	1/31	0x81F8...0x81FB/33273...33276

This parameter represents the unit in which *Capacity 100%* is expressed.
Available units:

Mass flow	Normal volume flow (1.01325 bar(a), 0 °C)	Standard volume flow (1.01325 bar(a), 20 °C)	Custom volume flow (Capacity Unit Type Pressure, Capacity Unit Type Temperature)
ug/h, ug/min, ug/s, mg/h, mg/min, mg/s, g/h, g/min, g/s, kg/h, kg/min, kg/s	uln/h, uln/min, uln/s, mln/h, mln/min, mln/s, ln/h, ln/min, ln/s, ccn/h, ccn/min, ccn/s, mm3n/h, mm3n/m, mm3n/s, cm3n/h, cm3n/m, cm3n/s, m3n/h, m3n/min, m3n/s, scfh, scfm, scfs, sccm, slm	uls/h, uls/min, uls/s, mls/h, mls/min, mls/s, ls/h, ls/min, ls/s, ccs/h, ccs/min, ccs/s, mm3s/h, mm3s/m, mm3s/s, cm3s/h, cm3s/m, cm3s/s, m3s/h, m3s/min, m3s/s	ul/h, ul/min, ul/s, ml/h, ml/min, ml/s, l/h, l/min, l/s, cc/h, cc/min, cc/s, mm3/h, mm3/m, mm3/s, cm3/h, cm3/m, cm3/s, m3/h, m3/min, m3/s, cfh, cfm, cfs



Because of the maximum string length of 7 characters, some unit names are abbreviated, for instance mm3n/m means mm³n/min.

Speed of Sound (Special parameter f1 float)

Type	Access	Range	FlowDDE	FLOW-BUS	Modbus
Float	R	1E-10... 1E+10	373	127/9	0xFF48...0xFF49/65353...62354

This parameter returns the traveling speed of sound in meters per second through the metered fluid, measured by the instrument.

3.4.7 Controller

The picture below is a simplified visualization of the PID controller algorithm (proportional, integral, derivative) used by digital Bronkhorst® instruments.

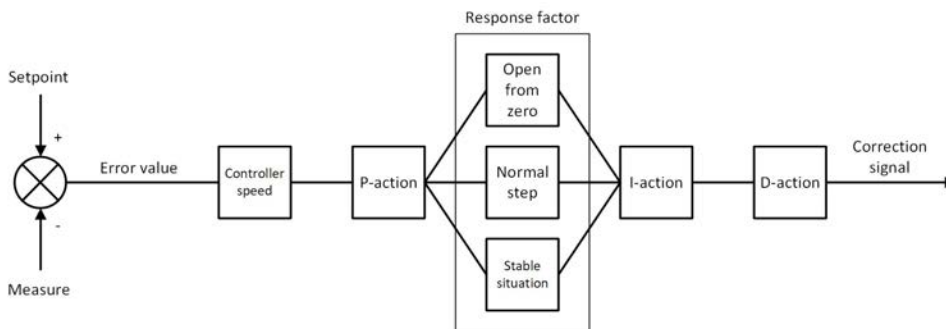

The controller speed controls the overall performance of the controller algorithm. Basically, to adjust the controller response, only the controller speed needs to be changed.

The algorithm is based upon the difference between the setpoint and the measured value (called the error value). The correction signal to eliminate the error is assembled from 3 components (giving the algorithm its name):

- The P-action (proportional) multiplies the error value by a constant factor, to adjust the measure towards the (new) setpoint.
- The I-action (integral) amplifies the correction signal with a factor depending on the integral of the error value over time.
- The D-action (derivative) reduces the strength of the P-action, to prevent overshoot when the (new) setpoint is reached.

The proportional action is enhanced by one of three additional response factors, depending on the control cycle stage:

- **Open from zero:** the setpoint is larger than zero and the measured value is below 2% of the full scale range.
- **Normal step:** the measured value differs more than 2% from the setpoint, typically after changing the setpoint (step).
- **Stable situation:** the measured value differs less than 2% from the setpoint.



Control characteristics are optimized during production. These parameters should only be changed if absolutely necessary, and only by or under the supervision of trained service personnel.

Controller Speed

Type	Access	Range	FlowDDE	FLOW-BUS	Modbus
Float	RW	0.2...5	254	114/30	0xF2F0...0xF2F1/62193...62194

This parameter sets the overall controller speed factor for the selected fluid. *Controller speed* is set ex factory between value '0.5' (slow) and '2' (fast). The default value is '1'.

PID-Kp

Type	Access	Range	FlowDDE	FLOW-BUS	Modbus
Float	RW	0...1E+10	167	114/21	0xF2A8...0xF2A9/62121...62122

PID controller proportional action, multiplication factor.

PID-Ti

Type	Access	Range	FlowDDE	FLOW-BUS	Modbus
Float	RW	0...1E+10	168	114/22	0xF2B0...0xF2B1/62129...62130

PID controller integral action in seconds.

PID-Td

Type	Access	Range	FlowDDE	FLOW-BUS	Modbus
Float	RW	0...1E+10	169	114/23	0xF2B8...0xF2B9/62137...62138

PID controller derivative action in seconds. The default value is 0.0.

Open From Zero Response

Type	Access	Range	FlowDDE	FLOW-BUS	Modbus
Unsigned char	RW	0...255	165	114/18	0x0E52/3667

Response factor, applied to proportional action when opening the valve from 0%.

- Default value: 128 (no correction)
- Other values adjust the controller gain (correction signal) as follows: $\text{Controller gain} = \text{Controller Speed} * \text{PID-Kp} * 1.05^{(\text{response factor} - 128)}$

Normal Step Response

Type	Access	Range	FlowDDE	FLOW-BUS	Modbus
Unsigned char	RW	0...255	72	114/5	0x0E45/3654

Response factor, applied to proportional action during normal control (at setpoint step).

- Default value: 128 (no correction)
- Other values adjust the controller gain (correction signal) as follows: $\text{Controller gain} = \text{Controller Speed} * \text{PID-Kp} * 1.05^{(\text{response factor} - 128)}$

Stable Situation Response

Type	Access	Range	FlowDDE	FLOW-BUS	Modbus
Unsigned char	RW 	0...255	141	114/17	0x0E51/3666

Stable situation response, applied when the controller is stable (within a 2% band around the setpoint).

- Default value: 128 (no correction)
- Other values adjust the controller gain (correction signal) as follows: $\text{Controller gain} = \text{Controller Speed} * \text{PID-Kp} * 1,05^{(\text{response factor} - 128)}$

3.4.8 Master/slave configuration (FLOW-BUS)

Normally, there is no communication between the instruments in a fieldbus system. The FLOW-BUS protocol, however, provides a feature to set up a master/slave relationship between two instruments. The typical behavior of a slave instrument is to automatically set its own setpoint relative to the output (measurement value) of its master.

The output value of any instrument in a FLOW-BUS network is automatically available to all other instruments without extra wiring. A slave instrument can also be a master to other instruments.

To set up a master/slave relationship between instruments, set parameter *Control Mode* of the slave instrument to 'FLOW-BUS slave' (value 2) or 'FLOW-BUS analog slave' (value 13), depending on how the setpoint should be calculated.

The slave instrument polls the output value of its master periodically and uses the slave factor to set its own setpoint relative to the master's.



To prevent damage to the instruments an/or the system(s) they are connected to, be sure to avoid circular references between devices on the same fieldbus. The FLOW-BUS system does not have a protection mechanism.

Master Node

Type	Access	Range	FlowDDE	FLOW-BUS	Modbus
Unsigned char	RW	1...128	158	33/14	n/a

Sets the master node for the instrument.

Note that this parameter is only effective in a FLOW-BUS network (RS-485).

Slave Factor

Type	Access	Range	FlowDDE	FLOW-BUS	Modbus
Float	RW	0...500	139	33/1	0xA108...0xA109/41225...41226

The controller output from the master instrument is multiplied by *Slave Factor*/100 % to get the slave instrument setpoint. In systems other than FLOW-BUS, *Slave Factor* is effective only if *Control Mode* is set to 'Analog slave', and the analog output signal of the master instrument is redirected to the input of the slave instrument.

Example:

- master output = 80 %
 - *Slave Factor* = 50
- ⇒ slave instrument setpoint = 80 % x 50 % / 100 % = 40 %

3.4.9 Device identification**User Tag**

Type	Access	Range	FlowDDE	FLOW-BUS	Modbus
Unsigned char[16]	RW	-	115	113/6	0xF130...0xF137/ 61745...61752

With this parameter, the instrument can be given a custom tag name, with a maximum of 16 characters.

Customer Model

Type	Access	Range	FlowDDE	FLOW-BUS	Modbus
Unsigned char[16]	RW 	-	93	113/4	0xF120...0xF127/ 61729...61736

This parameter is used to add extra information to the model number information, such as a customer-specific model number.

Serial Number

Type	Access	Range	FlowDDE	FLOW-BUS	Modbus
Unsigned char[20]	R	-	92	113/3	0xF118...0xF11F/ 61721...61728

Instrument serial number for identification.

BHT Model Number

Type	Access	Range	FlowDDE	FLOW-BUS	Modbus
Unsigned char[35]	RW 	-	91	113/2	0xF110...0xF117/ 61713...61720

This parameter shows the Bronkhorst® instrument model type information.

Firmware Version

Type	Access	Range	FlowDDE	FLOW-BUS	Modbus
Unsigned char[6]	R	-	105	113/5	0xF128...0xF12A/ 61737...61739

Revision number of the firmware

Identification Number

Type	Access	Range	FlowDDE	FLOW-BUS	Modbus
Unsigned char	RW 	0...255	175	113/12	0x0E2C/3629

Bronkhorst® (digital) device type identification number.

Device Type

Type	Access	Range	FlowDDE	FLOW-BUS	Modbus
Unsigned char[6]	R	-	90	113/1	0xF108...0xF10A/ 61705...61707

Device type information string; this parameter contains an abbreviation referring to the identification number.

3.4.10 Special parameters**Init Reset**

Type	Access	Range	FlowDDE	FLOW-BUS	Modbus
Unsigned char	RW	82/64	7	0/10	0x000A/11

Init Reset is used to unlock secured parameters (marked with a  symbol) for writing. It supports the following values:

Value	Description
64	unlocked, secured parameters can be read and written to
82	locked, secured parameters are read-only

At power-up, *Init Reset* is always set to 'Locked' (value 82).

Reset

Type	Access	Range	FlowDDE	FLOW-BUS	Modbus
Unsigned char	R	0...8	114	115/8	0x0E68/3689

This parameter is used to reset the program, counter, totalizer or alarms.

Value	Description
0	No reset
1	Reset counter
2	Reset alarm
3	Reset counter
4	Reset and disable counter
5	Reset firmware program (soft reset)
6	Reset <i>Alarm info</i> error bit
7	Reset <i>Alarm info</i> warning bit
8	Reset totalizer



The Reset parameter may be disabled by Reset Alarm Enable or Reset Counter Enable. Make sure the value is accepted by sending value 0 first.

Wink

Type	Access	Range	FlowDDE	FLOW-BUS	Modbus
Unsigned char [27]	W	0...9*	1	0/0	0x0000/1

Sending any text string value between 1 and 9 to this parameter makes the indication LEDs (if present) blink for a couple of seconds. This can be useful in order to identify a specific device in a large fieldbus network.

*) Modbus only supports value 14592

Control Mode

Type	Access	Range	FlowDDE	FLOW-BUS	Modbus
Unsigned int	RW	0...255	12	1/4	0x0024/37

Control Mode is used to select different control modes of the instrument and determines from which source(s) it accepts a setpoint. The following control modes are available:

Value	Mode	Instrument action	Setpoint source
0	BUS/RS-232	Controlling	Fieldbus/RS-232
1	Analog Input	Controlling	Analog input
2	FLOW-BUS Slave	Acting as slave instrument on FLOW-BUS	RS-485 only: FLOW-BUS master output x <i>Slave Factor</i> /100%
3	Valve Close	Controller disabled, valve closed	
4	Controller Idle	Controller disabled, valve frozen in current position	
7	Setpoint 100%	Controlling, setpoint fixed to 100%	
8	Valve Fully Open	Controller disabled, valve fully opened	
9	Calibration Mode	Calibration mode enabled (factory only)	
10	Analog Slave	Acting as slave of other instrument in analog mode	<i>Analog Input</i> x <i>Slave Factor</i> /100%
12	Setpoint 0%	Controlling, setpoint fixed to 0%	
13	FLOW-BUS Analog Slave	Acting as slave of other instrument on FLOW-BUS, slave factor is set by analog input signal	RS-485 only: FLOW-BUS master output x <i>Analog Input</i>
18	RS-232	Controlling, safe state deactivated	Fieldbus/RS-232
20	Valve Steering	Controller disabled, setpoint redirected to <i>Valve output</i>	

Value	Mode	Instrument action	Setpoint source
21	Analog Valve Steering	Controller disabled, analog input redirected to <i>Valve output</i>	
22	Valve Safe State	Force instrument in safe state	

Immediately after power-up, *Control Mode* is set to 'Analog input' or 'BUS/RS-232' automatically, depending on the (requested) default setting for analog or digital operation. If *Control mode* is set to value 0, 1, 9 or 18, the instrument returns to its default control mode at the next power-up or reset. Other values are retained after power-up or reset.

3.4.10.1 Default control mode

IO Status

Type	Access	Range	FlowDDE	FLOW-BUS	Modbus
Unsigned char	RW 	0...255	86	114/11	0x0E4B/3660

The instrument is set to accept a setpoint from either an analog or a digital source. Although this setting can be changed with parameter [Control Mode](#), the instrument usually returns to its default control mode at every power-up or reset. The default control mode can be set with parameter *IO Status*; to change it, use the procedures as described below.

Changing from digital operation to analog operation:

1. Set parameter *Init Reset* to 64 (unlocked)
2. Read parameter *IO Status*
3. Add 64 to the read value
4. Write the new value to parameter *IO Status*
5. Set parameter *Init Reset* to 82 (locked)

Changing from analog operation to digital operation:

1. Set parameter *Init Reset* to 64 (unlocked)
2. Read parameter *IO Status*
3. Subtract 64 from the read value
4. Write the new value to parameter *IO Status*
5. Set parameter *Init Reset* to 82 (locked)



The procedures described above do not change the value of parameter *Control Mode*. To apply the new default control mode, reset or restart the instrument.

3.5 Adjusting zero point

Zero-stability

The zero point of a Bronkhorst® flow meter/controller (the measurement signal that indicates the absence of a flow) is factory adjusted with water at approximately 20 °C and atmospheric pressure (ambient conditions), with the instrument positioned upright. Under normal circumstances, the zero point will remain stable. However, in rare cases (for example due to strong fluctuations in temperature and/or pressure), the instrument might develop a slight deviation of the measured value from the zero point, causing it to detect a flow when in reality there is none. Readjusting the zero point eliminates this deviation.



If the instrument still detects a (steady) flow while all valves are closed and the fluid system is leak tight, re-adjusting the zero point is recommended.

Prerequisites

Zeroing an instrument requires that:

- the ambient conditions (temperature, pressure) match those of the operating environment of the instrument.
- the instrument is filled homogeneously and pressurized with the operational media, according to the typical process conditions.
- the instrument has been warmed up sufficiently.
- there is absolutely no flow through the instrument; preferably, this is achieved by closing a valve immediately after the outlet of the instrument (control valve, shut-off valve).



Blocking the flow through the instrument is essential; zeroing an instrument while there is still a flow will lead to measurement errors.

Procedure

The zeroing procedure can be performed in the following ways:

- with the autozero function of the integrated user interface module
- manually (using the multifunctional switch)
- digitally (via RS-232 or fieldbus)

Regardless of the chosen method, the zeroing procedure takes approximately 25 seconds to complete.

3.5.1 Autozero function

The readout and control unit provides an automatic function for re-adjusting the zero-point of a flow meter, which automatically steps through the required parameter settings. This autozero function can be found in the *Advanced* section of the *Settings* menu:

1. In the *Settings* menu, select the *Advanced* item:
2. Enter the *Advanced* sub menu and select the *Autozero* item:
3. Enter the *Autozero* sub menu and select *Start auto zero*:
4. Press **↵** to start the procedure and wait until it has finished:

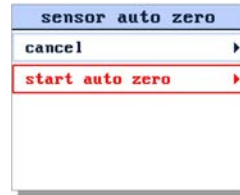

3.5.2 Manual procedure

To start the autozero function with the multifunctional switch, follow these instructions:

1. Change the setpoint of the instrument to 0 (zero).
2. Press and hold the multifunctional switch. After 4 seconds, the red LED ● lights up; another 4 seconds later the red LED extinguishes and the green LED ● lights up.
3. At that moment (which is after 8 to 12 seconds), release the switch.

The green LED starts to blink fast, indicating that the autozero procedure is in progress. After (successful) completion, the green LED lights up continuously, while the output signal is 0 % (parameter *Measure* = 0).

3.5.3 Digital procedure



Bronkhorst FlowSuite and FlowPlot provide an easy way to adjust the zero point of an instrument using RS-232 communication; the Autozero function automatically performs the procedure described here.

To adjust the zero point using digital communication, set parameter values in the following sequence (see section [General](#) for more information about instrument parameters):

Sequence #	Parameter	Value	Action
1	Setpoint or fSetpoint	0	stop flow
2	Init Reset	64	unlock secured parameters
3	Control Mode	9	enable calibration mode
4	Calibration Mode	0	reset calibration mode
5	Calibration Mode	9	start zeroing

The green LED starts to blink fast, indicating that the zeroing procedure is in progress. On completion, the green LED lights up, while the output signal is 0 % (parameter *Measure* = 0). At the same time, parameter *Control Mode* returns to its initial value. If the procedure is successful, parameter *Calibration Mode* changes to 0 (idle). If the procedure fails, *Calibration Mode* changes to 255.



After performing the procedure, remember to set parameter Init Reset to value 82 to lock secured parameters.

4 Maintenance



Inexpertly servicing instruments can lead to serious personal injury and/or damage to the instrument or the system it is used in. Servicing must therefore be performed by trained and qualified personnel. Contact your Bronkhorst representative for information about cleaning and calibration. Bronkhorst has trained staff available.

For general (non-hygienic) applications, the ES-FLOW™ needs no regular maintenance if operated properly, with clean media, compatible with the wetted materials, avoiding pressure and thermal shocks and vibrations. Units may be purged with a clean, dry and inert gas or flushed with a non-aggressive and non-corrosive cleaning liquid.

Hygienic applications require periodic cleaning and/or maintenance. See further for more information.

In case of severe contamination, cleaning the inside of the device may be required.

4.1 Cleaning



- *When ordered as a 3-A compliant instrument, the ES-FLOW™ 1xxl is suited for hygienic (food processing) applications and Clean-in-place (CIP).*
- *For CIP procedures, a minimum flow velocity of 1.5 m/s through the ES-FLOW™ 1xxl is recommended; this can be achieved with water at a flow rate of 1500 ml/min.*
- *The sealing surfaces of Tri-Clamp gaskets may require Clean-Out-of-Place (COP) cleaning (according to the instructions of the seal manufacturer).*
- *When the measuring tube gets clogged by highly viscous and/or sticky liquids, it can be cleaned manually, using a thin channel cleaning brush before flushing it with a cleaning liquid..*



The end user is responsible for validation of the cleaning procedure and results.

4.2 Calibration

The ES-FLOW™ has been factory calibrated. Periodical inspection, recalibration or verification of the accuracy may be subject to individual requirements of the user. Whenever necessary, contact your Bronkhorst representative for information and/or making arrangements for recalibration.

Bronkhorst certifies that the instrument meets the rated accuracy. Calibration has been performed using measurement standards traceable to the Dutch Metrology Institute (VSL).

5 Troubleshooting and service



- Electronic problems can be traced by restarting the equipment.
- If the equipment starts up normally, the measurement and control behavior can be checked by applying fluid pressure.
- To track down problems in the fluid system, depressurize the fluid system and disconnect the suspected unit from the process line. Dirt or clogging might be quickly detected by visual inspection of disassembled fluid connections.



If you suspect leakage, do not disassemble the device for inspection, but contact your Bronkhorst representative for service or repairs.

5.1 Common issues

Symptom	Possible cause	Action
Red LED glows continuously, display shows irregular measure readout	No liquid in measuring tube	Fill fluid lines with process liquid before starting measurement and control (see First use)
	Inlet pressure unstable (flow rate pulsating)	Eliminate pressure fluctuations, e.g. by installing a pressure regulator
Red LED glows continuously, display shows no flow	Hardware error	Contact your Bronkhorst representative
No (fieldbus) communication	No power supply	<ul style="list-style-type: none"> • Check power supply • Check cable connection • Check cable hook-up
	Invalid node address	Change node address (see Network configuration)
	Other	Reset instrument and/or restart master. If problem persists, contact your Bronkhorst representative.
No output signal	No power supply	<ul style="list-style-type: none"> • Check power supply • Check cable connection • Check cable hook-up
	Sensor failure	Contact your Bronkhorst representative
<ul style="list-style-type: none"> • Control behavior unstable • Red LED flickers or flashes irregularly 	Inlet pressure unstable (flow rate pulsating)	Eliminate pressure fluctuations, e.g. by installing a pressure regulator
	Gas accumulation in tubing	Flush the fluid system to remove gas
	Wrong controller settings	Adjust settings (e.g. with FlowPlot)
No flow (sending a setpoint has no effect)	No fluid supply	Check upstream components for obstruction, e.g.: <ul style="list-style-type: none"> • fluid lines • valves • filters
	Inlet pressure or differential pressure out of bounds	Set inlet pressure to a value within specifications
Flow rate or pressure rises, but never reaches setpoint	Piping, filters and/or control valve clogged or blocked	<ul style="list-style-type: none"> • Clean system (flush with clean, dry air or a non-aggressive cleaning liquid (e.g. ethanol or isopropyl alcohol)) • For external proportional control valves: supply 0...15 Vdc and operational inlet pressure to valve and slowly increase voltage. If valve does not open, clean parts and re-adjust valve
	Inlet pressure too low	Increase inlet pressure
	Outlet pressure too high	Check/decrease outlet pressure

Symptom	Possible cause	Action
	Process outlet blocked	Check process outlet and downstream piping
Measured value or output signal (much) lower than setpoint	Inlet pressure or differential pressure too low	<ul style="list-style-type: none"> • Increase inlet pressure • Use instrument in conditions it was designed for
	Piping or filters blocked or contaminated	Clean fluid system
	Supplied fluid type does not match configured fluid type	Supply equipment with other fluid or change fluid type in instrument configuration
Measured value or output signal indicates a flow, while there is none	Instrument not mounted horizontally or ambient conditions differ significantly from conditions stated on serial number label	<ul style="list-style-type: none"> • Follow mounting instructions • Use instrument in conditions it was designed for • Adjust zero point (see Adjusting zero point)
	System leakage	Check the system for leakage. Follow vendor instructions when installing third party components (e.g. adapters, tubing, valves)
Continuous maximum measured value or output signal	Inlet pressure too high	Check inlet pressure
	Sensor failure	Contact your Bronkhorst representative

5.2 Service

If you have a question about a product or if you find the product does not meet the specifications as ordered, do not hesitate to contact your Bronkhorst representative. To enable us to help you quickly and effectively, make sure to have the serial number (SN) ready whenever seeking contact with your Bronkhorst representative about a specific item.

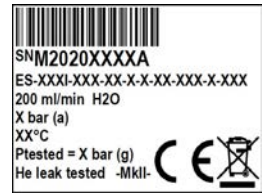

For current information about Bronkhorst® and worldwide service addresses, please visit our website:

 www.bronkhorst.com

Do you have any questions about our products? Our Sales department will gladly assist you selecting the right product for your application. Contact sales by e-mail:

 sales@bronkhorst.com

For after-sales questions, help and guidance, our Customer Care department is available by e-mail:

 aftersales@bronkhorst.com

No matter the time zone, our experts within the Customer Care department are available to answer your request immediately or take appropriate further action. Our experts can be reached at:

 **+31 859 02 18 66**

Bronkhorst High-Tech B.V.
Nijverheidsstraat 1A
NL-7261 AK Ruurlo
The Netherlands

6 Returns

6.1 Removal and return instructions

When returning materials, always clearly describe the problem, and, if possible, the work to be done, in a covering letter.

Instrument handling:

1. Purge all fluid lines (if applicable)
2. If the instrument has been used with toxic or otherwise hazardous fluids, it must be cleaned before shipping
3. Disconnect all external cabling and tubing and remove the instrument from the process line
4. If applicable, secure movable parts with appropriate transport safety materials, to prevent damage during transportation
5. The instrument must be at ambient temperature before packaging
6. Insert the instrument into a plastic bag and seal the bag
7. Place the bag in an appropriate shipping container; if possible, use the original packaging box

Add documentation:

- Reason of return
- Failure symptoms
- Contaminated condition
- Declaration on decontamination



It is absolutely required to notify the factory if toxic or dangerous fluids have been in contact with the device!
This is to enable the factory to take sufficient precautionary measures to safeguard the staff in their repair department.

All instruments must be dispatched with a completely filled in 'Declaration on decontamination'. Instruments without this declaration will not be accepted.



A safety information document containing a 'Declaration on decontamination' form (document no 9.17.032) can be downloaded from the **Service & Support** section of the Bronkhorst website (www.bronkhorst.com).

Important:

Clearly note, on top of the package, the customs clearance number of Bronkhorst High-Tech B.V.:

NL801989978B01

(only if applicable, otherwise contact your Bronkhorst representative for local arrangements.)

6.2 Disposal (end of lifetime)

If you are a customer within the European Union and wish to dispose of Bronkhorst® equipment bearing the symbol of a crossed out waste disposal bin, you can return it in accordance with the [removal and return instructions](#). Bronkhorst will then take care of proper dismantling, recycling and/or reuse (wherever possible). In the covering letter, mention that you are returning the product for disposal.

In countries outside the EU, disposal of electrical and electronic equipment (EEE) may be subject to local or national directives and/or legislation. If applicable, consult local or national authorities to learn how to handle EEE properly in your area.



Parameter index

Parameters

Parameters - Alarms

Alarm Delay Time	39
Alarm Info	39
Alarm Maximum Limit	39
Alarm Minimum Limit	39
Alarm Mode	39
Alarm New Setpoint	40
Alarm Setpoint Mode	40
Reset Alarm Enable	40

Parameters - Controller

Controller Speed	45
Normal step response	45
Open from zero response	45
PID-Kp	45
PID-Td	45
PID-Ti	45
Stable situation response	46

Parameters - Counter

Counter Limit	41
Counter Mode	40
Counter New Setpoint	41
Counter Setpoint Mode	41
Counter Unit	40
Counter Value	41
Reset Counter Enable	41
Totalizer Unit	42
Totalizer Value	42

Parameters - Device identification

BHT Model Number	47
Customer Model	47
Device type	47
Firmware version	47
Identification number	47
Serial Number	47
User Tag	46

Parameters - Fluid

Capacity 100%	43
Capacity Unit	44
Fluid Name	43
Speed of Sound	44

Parameters - Master/Slave

Master Node	46
Slave Factor	46

Parameters - Measurement and control

Analog Input	38
--------------	----

Fmeasure	37
Fsetpoint	38
Measure	37
Setpoint	37
Setpoint Slope	38
Temperature	37
Valve Output	38

Parameters - Network configuration

Fieldbus1 Address	42
Fieldbus1 Baud Rate	43
Fieldbus1 Parity	43
Fieldbus2 Address	43
Fieldbus2 Baud Rate	43
Fieldbus2 Parity	43

Parameters - Special

Control Mode	48
Init Reset	47
IO Status	49
Reset	48
Wink	48